

## Virtual test bench for Steering Software

Innovative test procedure for safety-critical components

## Network Slicing

Service- or application-oriented allocation of network resources

## Mobile document provisioning

ManageEngine solution supports Bay Logistik Enterprise Mobility Management



## „2021 – Now Delivery Is Made“



Dear Reader,

Now, 2021, delivery is made. Telecommunications and automotive companies have been investing in two key areas of innovation for quite some time: 5G and the paradigm shift in automotive drive technology. 2021 will for the first time see 5G offerings on a significant scale, and just about every carmaker will offer, launch, or introduce at least one all-electric model.

That a crucial part of this feat of strength took place in the middle of the greatest economic crisis since the end of World War II is all the more impressive – but the coronavirus may well have been a catalyst in some instances. This has given rise to a spirit of optimism in many places. It is precisely this kind of "let's get on with it" mentality that I often recognize among our customers and the members of the MicroNova team.

Now, something that probably brings a smile to the face of every company executive: Our Testing Solutions division has achieved technological leadership, thanks to increasing "cloudification" as well as modularization and a great deal of solution expertise in all aspects of battery and hydrogen testing solutions. Contributions in this issue of InNOVation, starting on page 4, discuss, among other

things, a virtual test procedure for the validation of control software, BMS tests and a general classification of the cloud topic in the testing environment.

IoT solutions are gaining momentum in the wake of 5G – which is why the Internet of Things is a natural extension of MicroNova's business model. Two articles starting on page 14 explain this in more detail. There are also aspects "directly within the mobile network" that merit close attention – such as the topics of network slicing, artificial intelligence and grey spot sharing. And, Alexander Seitz from Telefónica Deutschland talks about COM5.Mobile and network optimization in an interview.

As always the rule holds true that there can be no innovation without efficient IT. This is also underscored in this InNOVation by contributions from the areas of IT Management, IT Security and Project Management. And, each of these three aspects is so essential that it would be difficult to single out one; you can see this from page 36 onward.

If in the previous issue of our customer magazine Maximilian Karl, the company owner, had his say, it is now the turn of his father and MicroNova founder, Josef W. Karl, to speak up again and put all topics in the context of MicroNova's innovative strength.

I now wish you, as ever, an enjoyable read. And stay healthy!

Orazio Ragonese

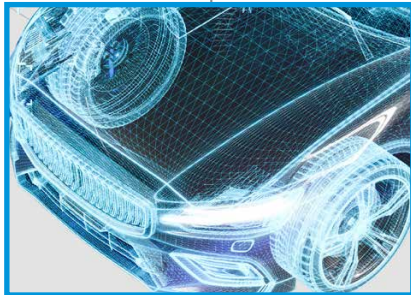

**002** // Editorial

**003** // Table of contents

## Testing Solutions

**004** // Virtual test bench for steering software

The VW Group relies on MicroNova for the validation of steering control units.

**008** // HiL: BMS testing with cell controller simulation

ElringKlinger relies on NovaCarts for testing battery management systems.

**013** // Just asking...

MicroNova COO Dr. Klaus Eder on the company's cloud strategy.



## Telco Solutions

**014** // IoT – new in the MicroNova portfolio

MicroNova supports medium-sized companies with custom-fit IoT concepts.

**016** // Ready-to-use IoT offering

The OpenGate© platform from MicroNova partner amplia))) enables customized IoT solutions.

**020** // Network slicing: a key 5G technology

MicroNova supports mobile network operators in a service- or application-oriented allocation of network resources.

**026** // Grey Spot Sharing in the 4G network

German mobile communications providers close wireless gaps by sharing network technology.

**028** // In conversation with Alexander Seitz (Telefónica)

The Head of Access Network Design, Performance and Optimization of Telefónica Germany on network optimization with COM5.Mobile.

**030** // Into the network with artificial intelligence

AI-based methods help realize new 5G network solutions. MicroNova is already using them for network data analysis, among other things.



## IT-Management

**036** // ManageEngine expands portfolio

Two new ManageEngine solutions for IT service providers and departments.

**038** // Enterprise mobility management for Bay Logistik

Bay Logistik manages mobile devices with Mobile Device Manager Plus from ManageEngine.

**040** // IT security - sysbus.eu talks to MicroNova

Interview with MicroNova employee Julia Reuter about IT security and data loss prevention.

**042** // 3 Tips for Successful Project Management

MicroNova uses three scenarios to show how projects can be organized even better with monday.com.

**046** // Short News + Supervisory Board

**048** // Imprint

# Virtual Test Bench for Validating a Steering Control Unit

Electronic control units for automotive applications are becoming increasingly complex – new strategies are therefore required for validating the software. MicroNova is working with the VW Group to develop a virtual test procedure for the reliable validation of steering software.

TEXT: Robert Evert, Andreas Drews, Stephan Schmidt PICTURES: © archy13 / Fotolia.com;  
© Open Studio / Shutterstock.com

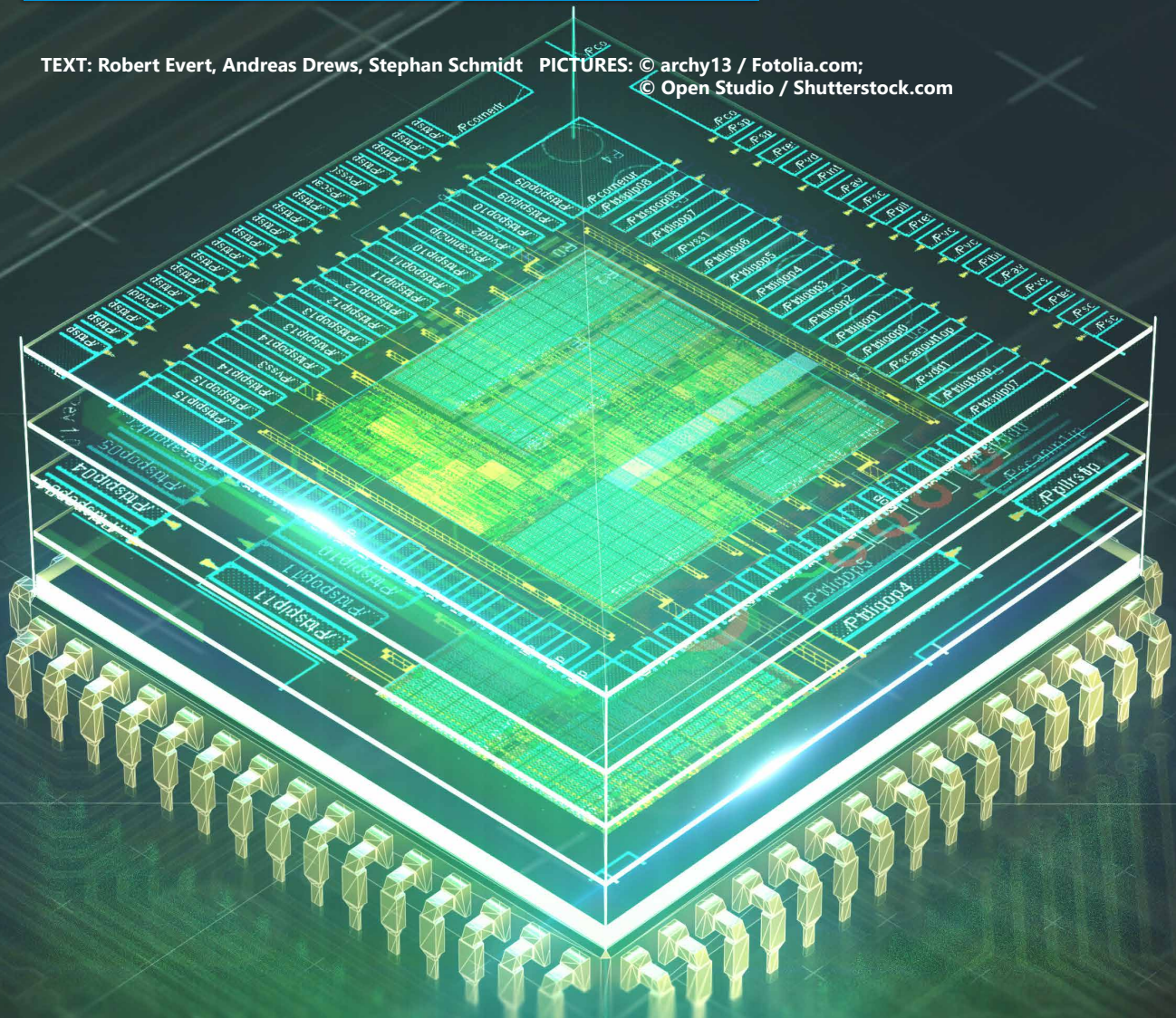

Automotive manufacturers and suppliers need new approaches and test systems for the validation of new driver assistance systems all the way through to autonomous driving. The aim of Volkswagen Group Components is the comprehensive and efficient validation of the software of a steering control unit.

Volkswagen and MicroNova have been developing various approaches to virtual testing since 2016, i.e. PC-based simulation for the validation of control unit software, on the basis of their long-standing cooperation in the field of HiL (hardware-in-the-loop) testing and test automation. The virtual electronic control unit (vECU) has always been at the center of all approaches. The jointly developed concept is an extension to previous HiL or SiL (software-in-the-loop) test benches.

This innovative approach by the testing experts at VW and MicroNova offers significant benefits. The steering software can be validated very early on in the development process in dynamic tests up to a classification according to ASIL D (see box). In addition, errors can be identified at an earlier stage and hence more cost-effectively. Linear scaling up using greater processing power also makes it possible to run tests in parallel. This provides the basis for the dynamic and cost-efficient installation of further identical test stands or their relocation to the cloud. Moreover, test cases can be more complex than with conventional systems, as the entire test bench can simply be halted whenever necessary – for example, to read out data memories or adjust configurations.

#### Virtual testing and virtualization of the ECU

The terms software-in-the-loop, virtual testing and virtual test bench are

frequently used buzzwords in ECU development. The core element of all implementations in these areas is the separation of the software test from the target hardware, i.e. the control unit. The test is usually carried out on PC systems, although calculations can also be offloaded to other hardware such as graphic cards or FPGAs if necessary. These systems can be run locally or in cloud data centers.

If this type of virtualization is extended to other connected peripherals, such as actuators, sensors and the vehicle bus, the result is a test bench that could also be implemented as an HiL system. According to the experts at MicroNova, such an expansion of the test systems used is unavoidable due to the stringent demands of testing control units for automated vehicles. The concept developed by VW and MicroNova allows test cases to be executed on a virtual test bench, with only minimal adjustments compared to conventional hardware test benches. HiL systems can therefore be supplemented and test capacities significantly expanded.

#### Implementation of the virtual test bench

The virtual test bench is based on a co-simulation of three software products. The main focus is on the simulation of the ECU at instruction level within a SystemC model that models data transfer between the individual components. The processor models used range from processor emulation to RTL (register transfer level) simulation, depending on the desired depth of simulation. The individual components are shown in the overview (Fig. 1). The system for testing VW's steering software is based on a replica of the processor and other connected components for system monitoring, engine control (GDU) and bus communication. In this case, the depth of

simulation includes not only the execution of the individual instructions of the processor, but also the implementation of all registers present as hardware, as well as the simulation of processor timing. The detailed representation of cache accesses and memory areas allows test engineers to identify errors deep within the system.

The virtual test stand consists of two redundantly configured threads, each with a multi-core processor. The processor communicates with the vehicle bus system, performs inter-ECU (IEC) communication and receives sensor signals from user inputs for steering and other assistance functions. It also provides a motor control function (hp). The motor model was implemented in the form of a circuit simulation, which also partially takes into account transient switching processes of the motor control function. The rest-bus simulation originates from a hardware test bench and is connected via a simulated vehicle bus in a slightly modified form.

#### Functional safety in accordance with ISO 26262

Risk assessment in accordance with ISO 26262 involves classification according to ASIL (Automotive Safety Integrity Level) A to D. Here, ASIL D represents the highest requirements, such as those necessary for autonomous driving. The new concept of the virtual test bench allows the steering software to be validated up to ASIL D classification at a very early stage in the development process.

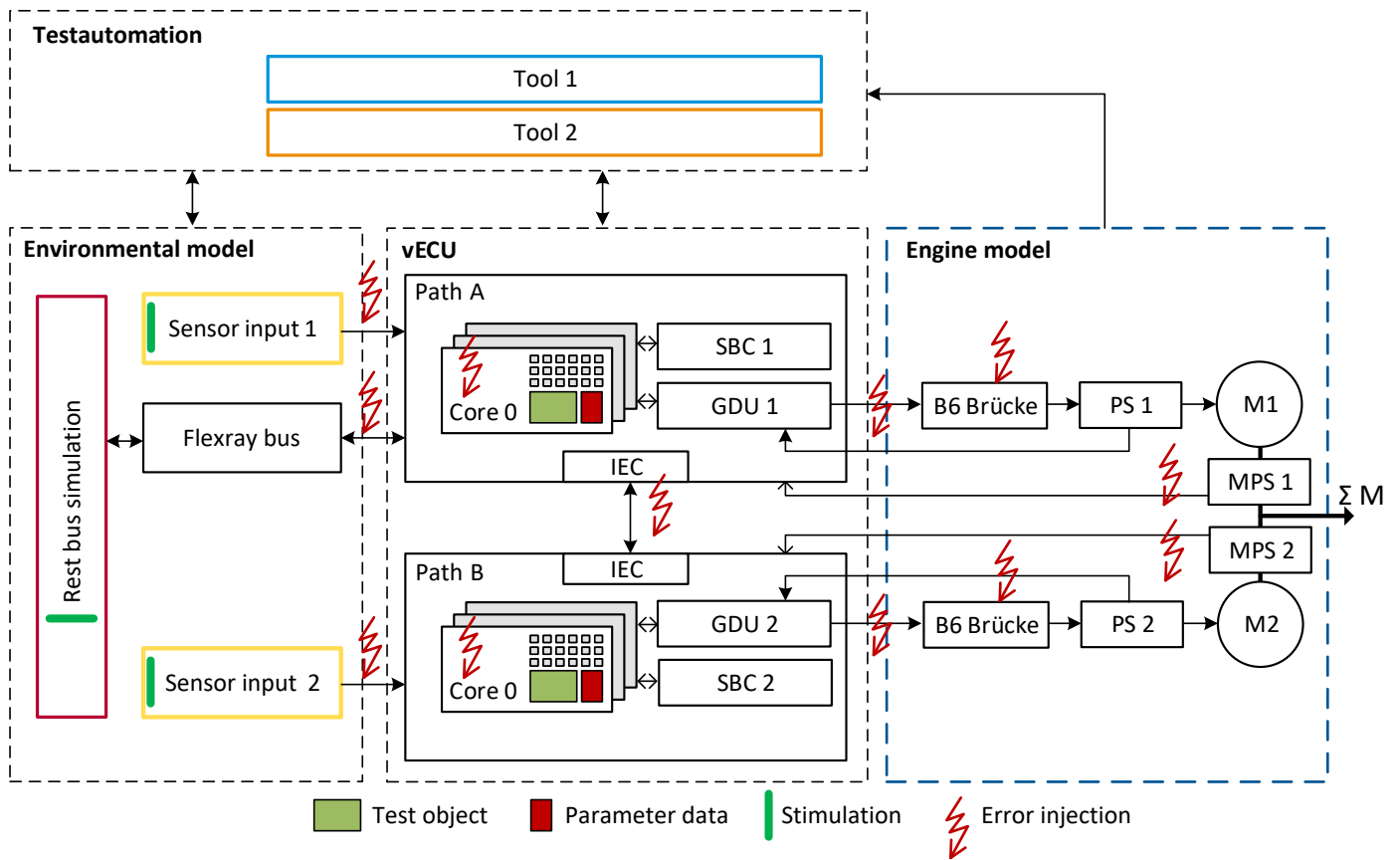

**1** Overview of virtual test bench with test automation.

At the beginning, a test automation solution (e.g. EXAM) starts the simulation for the test object, i.e. in this case the unmodified steering software (marked green in Fig. 1). The required calibration or learning data are automatically loaded at startup. It is possible to capture and manipulate data at any point in the virtual test bench thanks to the simulation properties. These may be memory areas, hardware registers, or input/output lines of the micro-controller within the processor model. Physical variables can also be specified and measured at the sensors and in the motor model. As the external system has no influence, this procedure ensures that the test is as reproducible as possible, thereby

ensuring consistently high test quality and reliable verifiability of the results.

**Possible applications of the system**

The virtual test bench offers a wide range of testing options that can be adapted to specific requirements. Fig. 1 shows examples of possible activation points in blue. As in real test benches, these are triggered via the bus system or via sensor inputs. What's more, the test bench provides a variety of interfaces that can be used to cause specific malfunctions and to measure whether the software under test shows the desired response. It is also possible to undertake significant

interventions in the test bench, allowing memory areas to be modified and the possibility of causing unsafe states or manipulation of the micro-controller's inputs/outputs. Such modifications are not possible at all on conventional hardware test benches, or only at great cost. The same applies, for example, to timeouts in monitoring functions or moving mechanical parts. In the ideal case, the system behavior of the virtual test bench corresponds completely to that of a hardware test bench.

The virtual test bench still has some limitations due to the model character of the components used: While ECU simulation, for example, is already very

accurate, the accuracy of motor simulation has so far been limited to basic motor behavior in selected operating states. An example test case consists of providing the sensors "Sensor input 1" and "Sensor input 2" with implausible or invalid values and at the same time interfering with the thread communication (IEC). The system must also achieve a safe baseline state in this extreme case.

**Conclusion**

The virtual test bench that MicroNova developed for VW has already been successfully used in several test loops of the steering software. The dynamic tests went beyond the possibilities of many hardware test benches. "Virtual ECU Level 4 was a new innovative way for us to validate high-availability steering systems for auto-

nomous driving," explains Matthias Glück, Project Manager Virtual ECU at Volkswagen AG. "Many tests were made easier and much more efficient as a result. We will continue to leverage the potential and opportunities we see with vECU L4 to expand and improve our testing procedures."

This will ensure comprehensive validation of safety-critical components at various points in the development process. High availability of the steering system is essential, in particular with regard to autonomous driving, and must be demonstrably proven during testing. Virtual test benches will be indispensable in the future for these technical requirements, such as high scalability and the large number of test variables that autonomous driving entails.

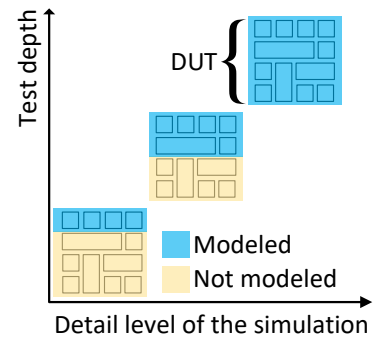

**2** The unmodified software must be executed on a fully simulated processor in order to validate safety-critical software systems. This procedure is also called Level 4 vECU in relation to an AUTOSAR-compliant software structure and does not require an assessment of the differences between the target software and the test state.

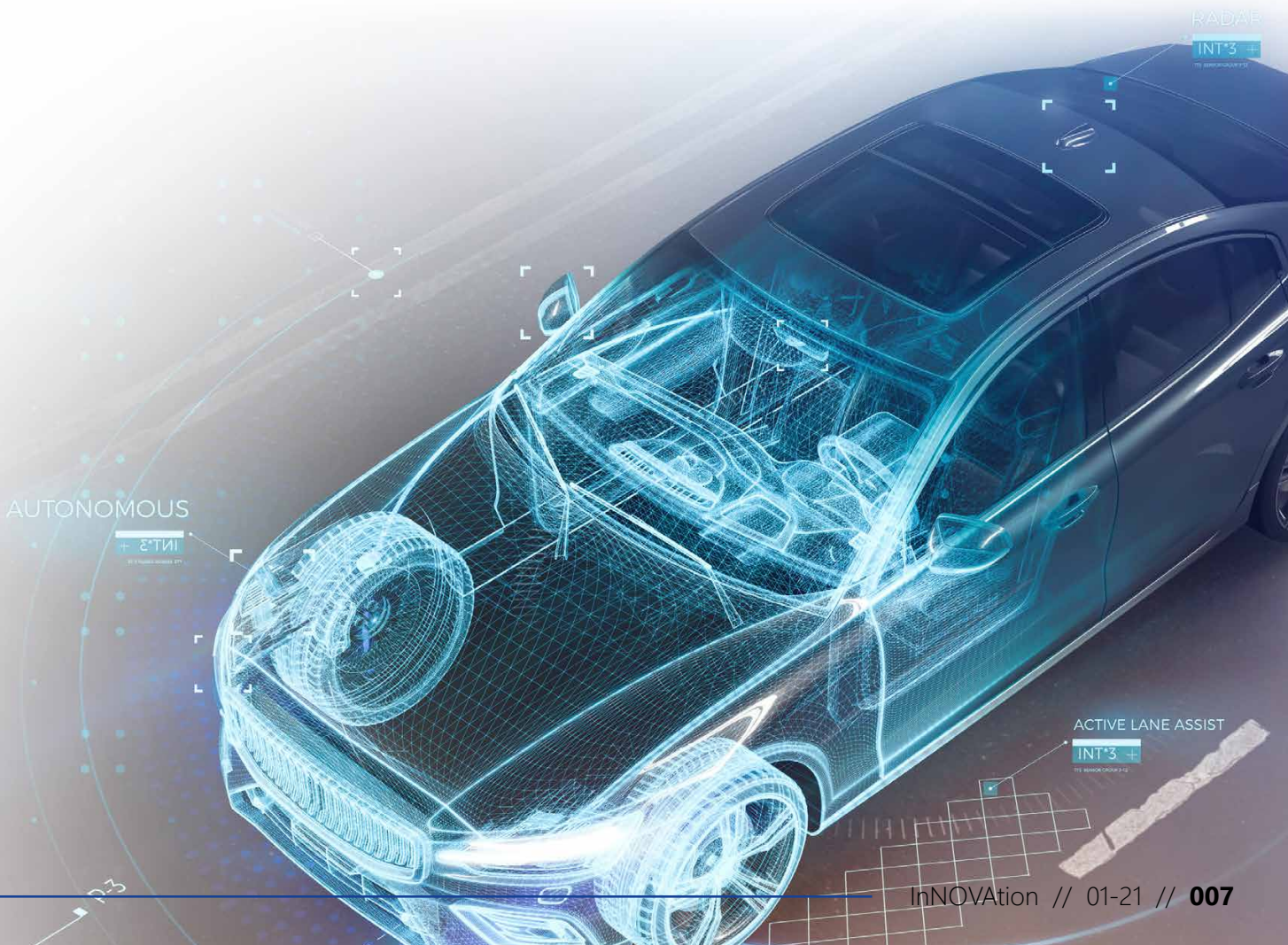

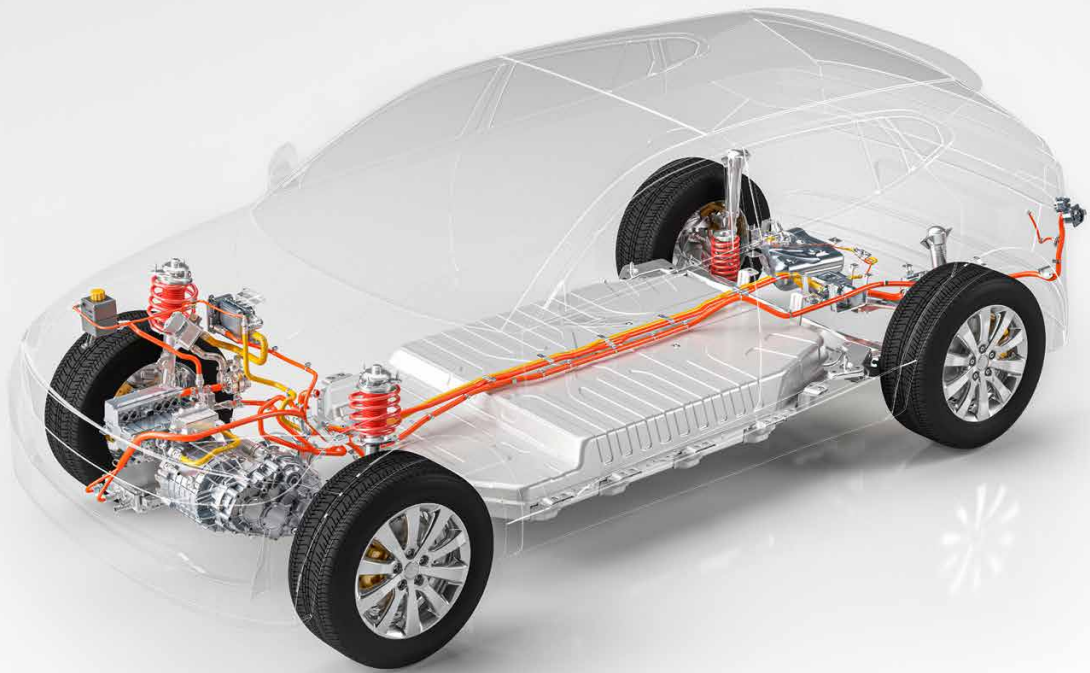

# BMS Testing on a HiL System Using Cell Controller Simulation

Automotive supplier ElringKlinger is expanding its testing expertise for battery management systems (BMS), placing its trust in the solutions and expertise of MicroNova's testing specialists.

**TEXT: Abdülkerim Dagli (MicroNova AG), Dr. Pierre Freundt (ElringKlinger AG)**  
**PICTURE: © Herr Loeffler / Shutterstock.com**

2020 saw around 194,200 new all-electric vehicles registered in Germany – a new record, representing a three-fold increase over the previous year. A significant part of this trend towards low-emission mobility is also attributable to the steady advances in battery technology, which is playing a key role

in the transformation of the automotive industry.

Companies like ElringKlinger AG, based in Dettingen an der Erms in Baden-Württemberg, have made a significant contribution to this. The automotive supplier has been working on

battery technologies for vehicles for over 15 years and is a leading German player in this field. Having started out with battery-related components such as cell contacting systems, ElringKlinger has now secured orders for complete battery modules.



ElringKlinger is expanding its portfolio to include new products and solutions as part of its transformation from a component supplier to a systems partner. This includes, for example, the development of a battery management system (BMS), i.e. the electronic control unit for electric-vehicle batteries. ElringKlinger has chosen the software and systems vendor MicroNova as its partner for this project. With its measurement and simulation solutions specially developed for e-mobility, its hardware-in-the-loop (HiL) system "NovaCarts Battery" is ideal for testing battery control units.

#### **BMS: Multiple requirements for test systems**

The battery management system plays a central role in battery storage systems: besides monitoring the individual cells, it also assures functional safety by preventing overcharging or excessive discharging of the cells. The BMS also provides the main communication interface to other control units in the vehicle. For example, in addition to measuring battery voltages, it can also work together with the speedometer and navigation system to calculate range.

The requirements for appropriate test benches for their reliable validation are therefore just as varied as the battery management system functions: The HiL systems must simulate all conditions to which a BMS can be exposed in a realistic and reproducible manner. This is the only way of ensuring and proving that the system is functioning correctly.

One of the key challenges in developing BMS test systems is the high-precision simulation of individual cell voltages. While overall voltage is up to 1,000 volts, it is necessary to display differences in the millivolt range.

Another focus is the exact simulation of the charging and discharging current of the battery system as well as the intermediate circuit with the voltages occurring there. In addition, a test system should be able to accurately simulate the entire battery, including cell temperature and aging, and simulate special signals (e.g. pilot, crash).

NovaCarts test systems for BMS meet these requirements with the required accuracy through hardware and software-based simulations, thus enabling realistic testing at an early stage of development.

#### **Cell module controller simulation – a unique feature**

Safe operation of lithium-ion battery cells requires the continuous monitoring of cell voltage and temperature. To this end, each of the modules, each of which groups together several cells in a battery, has its own monitoring electronics unit. This consists of cell module controllers (CMC), also known as cell sensor circuits (CSC) or cell supervision electronics (CSE). Each cell is connected to such a monitoring

module, i.e. a CSC. CSCs constantly measure the voltage and temperature of the cells and pass this information to the BMS.

CSCs are primarily circuit boards with one or more microcontrollers, also known as ASICs (application-specific integrated circuits). These chips are specially designed for monitoring lithium-ion cells. The CSCs are connected electrically to the cell poles via "sense lines" in order to measure the voltage of the cells. Additional lines can also be used to connect temperature sensors, which are relevant for ensuring optimum use and load of the cells.

As central battery components, the cell module controllers supply the BMS with information about the current state of the cells. The BMS would not be able to collect any useful information on the state of the battery without them and pass it on, for example, to calculate the remaining range. CSCs therefore undergo repeated optimization in the course of the development of a BMS. ASICs are most frequently subject to modification, as the development process often involves the

#### **About ElringKlinger AG**

As a global, independent vendor, ElringKlinger is a strong and reliable partner for the automotive industry. The company offers innovative product solutions for all drive types – whether passenger cars or commercial vehicles, with combustion engines, hybrid technology or all-electric vehicles – thereby contributing to sustainable mobility. Lightweight design concepts reduce vehicle weight, which in turn reduces fuel consumption and CO<sub>2</sub> emissions in internal combustion engines and increases the range for alternative drive systems. ElringKlinger positioned itself early on as a specialist in electromobility with cutting-edge battery and fuel cell technology and electric drive units. The company is continuously developing its sealing technology for a wide range of applications. Its shielding systems ensure optimum temperature and acoustic management throughout the vehicle. Dynamic precision parts from ElringKlinger can be used with all drive types. Engineering services, tooling technology and products made of high-performance plastics – also for sectors outside the automotive industry – round off the portfolio. In total, around 10,000 employees at 44 locations worldwide work within the ElringKlinger Group.

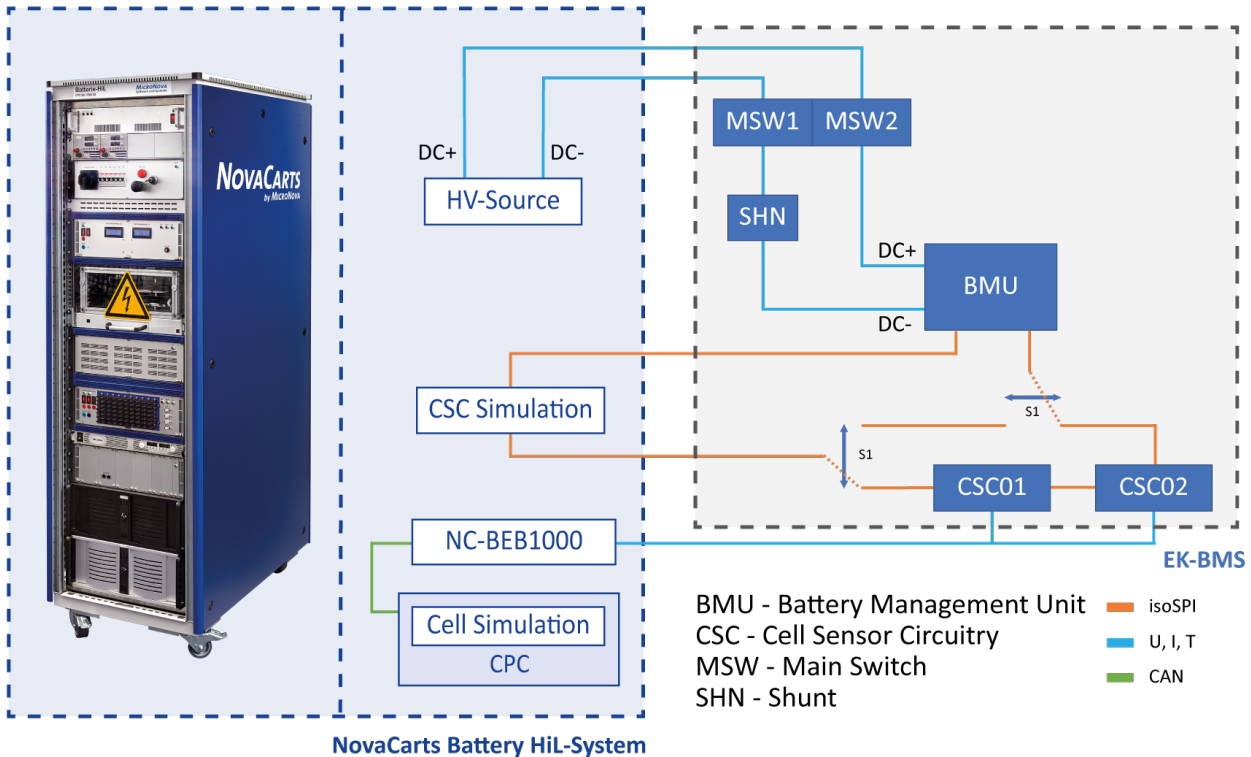

**1** Functional scheme of the BMS HiL system used at ElingKlinger.

**Positive trend for e-cars**

At around 194,200, electric vehicles achieved a share of just under seven percent of total new registrations in 2020, while conventionally powered cars accounted for around 74 percent. Hybrid vehicles accounted for a further 18 percent and natural gas and liquefied petroleum gas for a further one percent.

The target set by the German government in 2013 of one million electric vehicles on Germany's roads by 2020 was therefore unfortunately not met. However, the latest registration figures indicate a clear trend in society and a rethink towards more environmentally friendly and sustainable mobility.

integration of chips that are more powerful and more suitable for the application in question. Replacing ASICs can be time-critical for development, as they also play an important role in communication with the BMS. This is because CSCs are not always available in time for validation tests when the new ASICs are introduced.

In this purpose, MicroNova offers a simulation solution that emulates ASICs and their function in the BMS-CSC network. This CSC simulation is based on an FPGA-based hardware solution that can be used both on the HiL system and as a desktop application. The associated software allows a choice between different ASICs for simulation. This approach allows validation tests for the BMS to be started at a very early stage, since no real CSC components are required. Moreover, CSCs from different manufacturers can

be easily tested in combination with the BMS – without significant change-over and downtime or conversion costs. MicroNova's CSC simulation currently supports chips from Texas Instruments, Analog Devices, Linear Technology, and MAXIM Integrated. Simulations for additional chips can be developed on demand.

**Trust and cooperation on eye level**

ElingKlinger's development and test engineers were able to draw on the decades of experience of MicroNova's consultants and project engineers in the fields of test & validation, simulation development and project management when establishing a test process for their own BMS development. Even the initial meeting and the joint preparation of specifications were characterized by a spirit of partner-

<sup>1</sup> <https://www.faz.net/aktuell/wirtschaft/wirtschaftspolitik/eine-million-elektroautos-bis-2020-merkel-haelt-an-absatz-ziel-fest-12196498.html>

ship and goal-oriented cooperation. Close contact was also maintained with those responsible at ElringKlinger during the implementation of the project. Regular updates on the status of the HiL setup and the implementation of the software elements meant that changes could be introduced at any time, even at short notice.

"We have expanded test capacities in the area of battery storage as well as module and cell testing in order to continuously broaden our e-mobility portfolio and have invested in corresponding test benches with climate function. A major factor in this is the ability to master the battery management system as well. In addition, the development and validation of key components such as the BMS form core elements of our develop-

ment and testing strategy," says Dr. Pierre Freundt, Head of Battery Testing & Validation at ElringKlinger, explaining the company's motivation. "The decisive factor in choosing MicroNova as a project partner in the field of HiL testing was, apart from its many years of experience in testing battery management systems, its high level of expertise in simulating cell module controllers."

The "NovaCarts Battery" BMS HiL system was commissioned on schedule. This was partly carried out on site at ElringKlinger, but for the most part remotely. In addition to a detailed briefing on the test system, training was also provided on how to operate the hardware and software. Both the HiL support engineers at MicroNova's corporate headquarters in Vierkirchen

and the engineers at the Leonberg site are available to assist in ongoing operations.

### Summary

The transformation in mobility is advancing, and battery technology has a central role to play in this. High-quality products and excellent cooperation have been impressive in the implementation of further tangible steps from the very outset. ElringKlinger AG has already embarked on the first enhancements to the CSC simulation, which will lead to even closer cooperation between the two companies. The focus is on further use cases in the context of electromobility.

# Red Hat Innovation Award

## MicroNova supplies key components for VW innovation project

**TEXT: Editorial staff**

Every year, the open source provider Red Hat honors five particularly innovative customer projects with the "Red Hat Innovation Awards". This year, one of the award winners is Volkswagen AG.

To improve the speed, scalability and consistency of testing ECUs for modern vehicles, VW Group used Red Hat technology to develop a test environment that combines virtual and real-

world testing. With this new environment and an architecture created with "Red Hat Open Innovation Labs", the VW Group's development division improved the integration of components, introduced self-service provisioning, and reduced system testing costs by 50 percent.

MicroNova congratulates VW on their success! We are proud to be able to help develop forward-looking stand-

ards such as the Connected Mixed Reality (CMR) environment and to contribute to the success of this project with some of our products. The MicroNova software "NovaCarts Virtual" for HiL systems, for example, is an important component for CMR as a simulation node.



# MicroNova Live!

Meet our experts here.

TEXT: Editorial staff PICTURE: © Brian A Jackson / Shutterstock.com

Events – the real ones, not virtual ones – have been rare in recent months for reasons we all know. However, there are now increasingly optimistic plans for some industry events. Our experts from the Testing Solutions division are already looking forward to two important dates in autumn. We hope to finally meet you in person again at 'f-cell Stuttgart' and the 'Battery Experts Forum'!

## **f-cell Stuttgart – Energizing Hydrogen Markets Haus der Wirtschaft, Stuttgart September 14.-15, 2021**

At the two-day event, international hydrogen and fuel cell experts will provide an extensive overview of relevant markets and industries as well as technological advances in alternative propulsion.

As part of the interactive format, MicroNova will be present together with its partner Smart Testsolutions. The companies will present their cooperation in the areas of fuel cell measurement technology, HiL testing & validation for ECUs and control elec-

tronics as well as monitoring of fuel cells and electrolyzers (Booth 23, List Hall).

## **Battery Experts Forum Messe Frankfurt, Hall 6.0 October 5.-7., 2021**

At the three-day Battery Experts Forum at the Congress Center of the Messe Frankfurt, MicroNova will provide information on how to validate battery management systems in a time and cost-effective manner.

Come and see our presentation "Simplification and cost reduction in testing Battery Management Systems" and learn more about the "NovaCarts Battery" HiL system.

### **Presentation times:**

- » Tuesday, 5 Oct. 2021, 3:20 pm – 3:35 pm, Business Presentation Lounge
- » Thursday, 7 Oct. 2021, 2:00 pm – 2:30 pm, Conclusion Room

Contact person and speaker:

**Abdülkerim Dagli**  
[sales-testing@micronova.de](mailto:sales-testing@micronova.de)  
 +49 8139 9300-0

## **Webinars**

In order to also keep you up to date virtually with the latest solutions and technologies, MicroNova offers free webinars. If you are unable to attend live or have missed a date, you can find the recordings here: [www.micronova.de/en/testing/videos](http://www.micronova.de/en/testing/videos)

Further events, webinars and presentations will be added to our schedule on an ongoing basis. Visit our website at [www.micronova.de/en/testing-events](http://www.micronova.de/en/testing-events).

## **Testing Solutions Newsletter**

Have you already subscribed to our newsletter? Sign up to receive regular updates on MicroNova's products, solutions, and services. You can of course choose your main areas of interest and your preferred language (DE/EN).

Sign up now at [www.micronova.de/en/newsletter](http://www.micronova.de/en/newsletter).

# Just asking...

Dr. Klaus Eder, COO, MicroNova AG

## Cloud solutions now seem to be everywhere, but the feasibility of such applications differs depending on the area of use. What strategy is MicroNova pursuing in this regard with its three business units and what is the “cloud status” of its products?

The term “cloud” is actually very old, having been coined by IBM back in the 1950s. It would therefore be easy to get the impression that there is no longer any innovation here and that technology has long since found its way into all areas. There is in fact already a huge range of applications in the consumer sector. Many people maintain their music and movie collections “in the cloud”, and numerous online services are based on cloud technology. The use of cloud technology has not yet been possible in the high-tech domains of enterprise applications in which MicroNova operates, or at least only to a very limited extent.

The MicroNova IT Management business unit was the first where cloud-based products played a significant role several years ago. It was less the availability of solutions than users’ concerns about data protection and security that slowed down the progress of this technology. However, highly secure solutions hosted in German or European data centers have now become established, and the initial reticence has been successfully overcome. Within our company, today we see the highest growth rates in the context of cloud-based products by ManageEngine, which we distribute exclusively in Germany.

The cloud era is also just beginning in our Telco Solutions business. This has been triggered by the major technological upheaval associated with the transition of mobile networks to the new 5G technology: from proprietary technology of the major manufacturers to open-source-based frameworks. This change has been accompanied by a shift of the entire infrastructure into the cloud. Of course, our products from the COM5.Mobile family and the COM5.SDN Mediator, which is based around the new 5G architecture, will also soon be available as cloud-based versions.

However, the most interesting development for me in terms of cloud-based solutions is happening right now in our Testing Solutions division. Hardware-in-the-loop (HiL) systems have always been characterized by such high real-time requirements that for a long time switching to cloud solutions was not thought to be possible. We have now succeeded in breaking down this barrier with our NovaCarts virtual technology. We have been working consistently on making all our HiL technology cloud-enabled for a number of years – even though there were no sufficiently powerful cloud solutions available at the beginning. The situation has changed significantly.

Clouds are now available that can easily deliver the generally required cycle time of 1 ms in a HiL system – or even significantly shorter times – in real time. Our “NovaCarts Virtual” product range makes it possible to implement various test setups with ease: from real HiL systems in a cabinet to connected mixed reality environments as a hybrid form as well as purely virtual cloud test benches. This has led in a quantum leap in terms of flexibility and potential cost savings for our customers. Of course, our EXAM test automation solution, with the associated Test Cloud Controller (TCC), also integrates seamlessly into this cloud infrastructure for testing vehicle electronics.

I am therefore very pleased that we can now make almost all of our products available in a cloud environment. We are ideally equipped to deal with the technological changes currently taking place thanks to our product developments of recent years.

# IoT – New to the MicroNova Portfolio

The Internet of Things (IoT) is opening up wide-ranging new possibilities for linking physical and virtual objects, allowing them to be used more intelligently. At the beginning of 2021, MicroNova added an official IoT offering to its portfolio.

TEXT: Georg Kiefer | PICTURE: © jamestohart / Shutterstock.com

Whether new services or direct access to valuable data, for example from machinery: MicroNova has been paving the way into the Internet of Things for companies with a dedicated offering since 2021 – namely through a comprehensive and forward-looking IoT portfolio. Using this, companies can capture data from interconnected devices, sensors, and machines, analyze it in the cloud, evaluate it, and incorporate it into IoT concepts.

The technical basis for the new offering is the expertise that has long been available and implicitly used at MicroNova. Companies in various high-tech industries, including automotive, telecommunications, energy, and others, have for over 30 years benefited from the tried-and-tested knowledge on optimizing processes, reducing costs, generating new business models, and improving the safety of systems.

**MicroNova knows what medium-sized companies need – and is paving the way for them into the IoT age**

At MicroNova IoT components and solutions are available from a single supplier, from data acquisition and processing, to data communication and data analysis. The MicroNova team works closely with the Spanish company amplía)), which specializes in connecting devices and business processes through the IoT. Thanks to this partnership, companies receive custom solutions using the OpenGate© Framework developed by amplía)).

This means they benefit from the advantages of the IoT: Because by linking the “Things”, data can be transformed into valuable information, which in turn, depending on the proj-

ect, helps to reduce costs or create completely new products and services – right through to transformed business models. An example use case can be found on page 18 of this issue and more examples can be found at <https://www.micronova.de/en/telco/iot.html>.

The scope of services of the new portfolio includes the analysis of relevant technologies and requirements, and the selection of devices and sensors including the management of any suppliers or partners involved. MicroNova also provides support in architecture design, system integration, data evaluation and dashboard design, as well as an optimized process control system. Thanks to amplía)))’s years of experience, companies receive a cost-optimized foundation for long-term success – regardless of the maturity of their IoT project.

### Change management for increased user acceptance

New processes and technologies only realize their full productivity potential when users apply them consistently and sustainably. One methodology that has proven itself in practice is to maximize user acceptance through a change management process.

This means even active processes can easily be adapted in retrospect without jeopardizing the consistency of the data and workflow instances. MicroNova focuses on building projects in partnership with customers – from initial discussions through to training for usage and maintenance.

### The Framework

MicroNova partner amplia))) has been developing the IoT platform OpenGate© since 2005, which has proven its abilities in many IoT projects at well-known companies. OpenGate© is the underlying system that collects and processes information from all devices, which the user can view, analyze, and evaluate. It allows companies to standardize (normalize) data and provides the results for optimal evaluation via dashboards and integrated business intelligence methods.

Furthermore, a high degree of automation is ensured. This automation

can be adapted to individual needs through extensive rules. A powerful fault management system provides for the evaluation of events, complete alarm handling, and connection to external ticketing systems.

OpenGate© offers a range of possibilities that allow companies to create economic added value through fitting business models or to reduce or keep costs low – for example, through cheaper maintenance or avoiding unnecessary service calls:

- » **Connectivity and vendor independence:** Simple integration of devices and logs
- » **Data management and mass processing:** Measurement and operating data on hardware, software and connectivity, error detection/prevention
- » **Intelligent data collection, processing, and analysis:** Collecting, normalizing, and processing all relevant data to extract key information
- » **Security and high levels of availability:** Performance of a secure IoT platform, designed for several million connected devices

### OpenGate© eSIM/SIM Management for IoT applications

This product, based on the OpenGate© IoT Framework, provides centralized SIM and eSIM management for multi-operator environments – ideal for companies with lots of devices in the field, such as private campus networks. It can communicate with literally any mobile communication technology (2G, 3G, 4G, NBIoT, LTE Cat-M, etc.) and supports the operation, management and monitoring of eSIMs and SIMs.

Comprehensive functions for remote monitoring of all elements involved in the SIM management process are included. Using a web-based application, users can evaluate the data based on rules and using automation. If there are errors, custom alarms notify users immediately. This enables companies to quickly set up large IoT environments with their own eSIM/SIM management and provide highly reliable and performant services.

#### Requirements

With eSIM/SIM Management, it is possible to manage eSIMs and SIMs from any communication provider. If the provider does not have its own M2M management portal, the prepared information can be provided via a bulk upload tool. Alternatively, integration with other platforms is possible via their interfaces. This only requires API access rights to the provider platforms with SIM permissions and connectivity to the respective infrastructure elements (Radius). Thanks to an integration API, companies can also seamlessly integrate their own processes with the OpenGate© eSIM/SIM Management (e.g. ticketing systems, etc.).

### Summary

By bringing together the tried-and-tested amplia))) platform and our extensive industry and technology expertise, MicroNova is immediately able to transform data into value-added information – forming the basis for new business models and additional revenue potential.

# Ready-to-Use IoT Solutions

IoT solutions are usually customized for maximum added value – still, they can often be reused in comparable environments.

TEXT: Editorial staff PICTURES: © jamesteohart / Shutterstock.com; © amplia)))





The OpenGate© IoT Business Suite has been developed by MicroNova partner amplía))) on the basis of the OpenGate© IoT Framework and offers dedicated industry solutions. The main advantage for businesses: Building on a specifically prepared and proven system, by working with MicroNova they can create their own custom IoT solution – very quickly and cost-effectively in terms of set-up and operation.

- » **Quick implementation of new use cases:** The Business Suite includes all the tools required for business data mining and the analysis of IoT devices. The aim is to create solutions that are appropriate for the business case on the basis of existing features in the shortest possible time and with minimal cost.
- » **Transform the complex abundance of data into relevant information:** With the OpenGate© IoT Business Suite, companies receive the essential features for optimized daily operations by being able to access a predefined and proven, yet flexible toolkit.
- » **Monetization:** A transparent assessment of return on investment is made possible by companies defining rules, reports and processes to collect, measure and control the required information.
- » **Custom business cases:** Organizations can structure their business model requirements directly in the IoT world without having to write a single line of code.

- » **Integration with IT management:** User-defined reports with precise information help to get all departments on board.
- » **Real-time measurement of results:** Customized dashboards make it possible to assess the status of the solution, simulate it, and proactively make resilient decisions.

### IoT for SMEs – tailor-made for every industry with MicroNova

Whether new services or direct access to valuable plant and machine data: MicroNova knows what medium-sized companies need and helps them enter the IoT age – with an extensive and forward-looking portfolio.

With all components and solutions from a single supplier, from data acquisition and processing, to data communication and data analysis. This means that medium-sized companies can now also benefit from the advantages of the IoT inexpensively without having to set up costly and ponderous enterprise solutions. Our motto: "SME for SME; we understand your requirements".

MicroNova partner amplía))) has already developed various solutions – based on the OpenGate© IoT Framework or the OpenGate© IoT Business Suite – that are precisely tailored to the requirements of specific industries: OGTrack and OGSmartMetering. This article introduces OGTrack. Information about OGSmartMetering is already available at <https://www.micronova.de/telco/iot/loesungen.html>.

### OGTrack: Asset Tracking & Monitoring

OGTrack allows companies to track valuable assets anytime, anywhere – across wide-ranging process chains. The cloud-based solution is ready to use and is based on the OpenGate© IoT Framework. As such it offers a complete toolset for optimized asset tracking and monitoring.

OGTrack covers the communication and a pre-configured deployment of the OpenGate© platform in addition to the ready-to-use devices. Companies can immediately and very easily start using it as part of a Proof of Concept (PoC) or even as extensive use case. Logistics and industrial firms involved in the transport of container systems, the transport and/or use of vehicles etc. can benefit from the solution in particular.

For example, OGTrack makes it possible to check carriers, containers and trailers:

- » Improve delivery/production planning
- » Reduce idle times
- » Avoid lost shipments
- » Reduce costs
- » More and better delivery information

### Components of OGTrack – get started with the IoT immediately

OGTrack improves the tracking and precise geolocation of any asset. Status monitoring and usage statistics improve the performance of the services and therefore the added value for companies. The solution is compatible with almost any tracker (based on OpenGate©'s Connector Factory). For optimal deployment, amplía))) recommends the use of VTrack.

**Highlights**

- » Web-based SaaS solution, accessible via an intuitive user interface
- » Pinpointing and traceability
- » Real-time detection of defined events (geofencing, unplanned stops, movement, etc.)
- » Monitoring of additional parameters (position, jolts, inertia, temperature, etc. can be logged)
- » Simple integration into existing systems
- » Full remote control of the entire inventory (asset/device/communication)
- » KPIs & custom dashboards and reports according to user type
- » Sorting according to definable parameters
- » Rule-based engine: create custom alarms and automatic action rules

**Conclusion**

Companies usually have already achieved a high level of productivity in their existing processes. Significant efficiency gains therefore require effective, innovative concepts that support new ideas and business models. This is precisely what MicroNova and amplia)) make possible – through a powerful combination of engineering,

planning and design skills as well as industry know-how. Still, there is no need to reinvent the wheel every time. With often only minimal changes to existing solutions, companies in all industries that want to achieve comparable added value can start their own IoT project within a short space of time and at low cost.



## IoT Testimonial: Optimized warehouse and logistics chains with OGTrack

A European logistics and transport company wanted to track metal containers used for shipping motorbikes – from the time they leave the factory premises until they arrive at the dealership. Despite an extremely generous stock of transport containers, the lack of information about their current whereabouts was leading to delivery delays and ultimately to dissatisfied customers. The company’s goal therefore was to minimize these costly disruptions and to obtain the neces-

sary information about the locations of containers at any given time, in a structured manner and integrated into existing systems.

The solution was a concept to track the transport containers remotely and in real time – throughout the entire shipping process. Sensors in the metal boxes constitute the hardware side of the solution. Using the “Secure Directed Diffusion” (SDD) protocol, optimized for sensor communication,

the OpenGate© platform collects the data for further analysis. Container locations and capacity usage can be queried in real time; their status and movement profile including stop times are also available anytime and anywhere. Automatic alarms indicate when a container has delivered its consignment and remains motionless for more than one day. This allowed the company to minimize expensive periods during which containers were empty and optimize their storage.



*„With MicroNova and amplía))) joining forces, we are looking forward to great IoT projects in Germany that will help our clients thrive. MicroNova’s result-driven approach and amplía)))’s leading technology both represent the expansion of new business models and the optimization of existing operations.“*

– Javier Martinez,  
CEO,  
amplía)))

**Our Partner amplía)))**

amplía)))’s mission can be summarized as helping users to optimize their processes and digitize their business in all phases of the IoT (Internet of Things) value chain. More than that, MicroNova’s partner sets great store by its own employees, too. There is a strong emphasis on ideals such as transparency, diversity and a collaborative environment. With a highly qualified and experienced team of 35 employees, amplía))) develops its portfolio of products and solutions entirely in-house, focusing on effective quality assurance and robust security mechanisms for its IoT and M2M solutions. All this is evident in its OpenGate IoT Platform designed from the ground up as a performant and reliable layer-based architecture. A current total of over twelve million managed entities, more than ten million daily operations, and around eight million transactions speak for themselves – as well as being scored for three years in a row as one of the best IoT platforms in the world by MachNation<sup>1</sup>.

The screenshot shows the MicroNova website with a navigation menu (Company, Testing, Telco, IT Management, Career) and a sub-menu (Mobile Radio Networks, IoT, News). The main content area features a red box titled "Internet of Things (IoT): Our Service Portfolio" with the text: "Powerful architecture, IoT infrastructure including devices, system integration, optimized processes and data analysis". Below this, there are sections for "IoT: The Internet of Things" and "IoT for small and medium-sized enterprises – with MicroNova!".

**www.micronova.de and the IoT**

Products, solutions and references – these form the core content of MicroNova’s new IoT website. Together with a few introductory words for newcomers to the Internet of Things, the website offers in a concise and clear manner exactly what the IoT solutions from amplía))) themselves stand for: getting up to speed quickly and easily. All relevant information is included at the same time in order to convey a more detailed understanding of the potential benefits and processes as well as the products and technologies. And naturally we have also remembered the most important thing of all: a contact option for your next steps on your path to the Internet of Things.

[www.micronova.de/telco/iot.html](http://www.micronova.de/telco/iot.html)

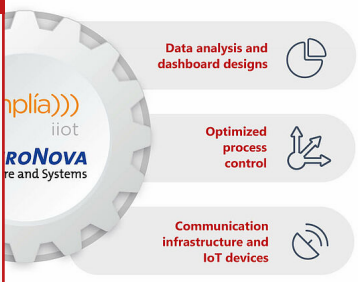

**asily with the right partner**  
 ight decisions to achieve a powerful general architecture of the OpenGate® IoT ar to convert their data into real usable figures and use these for the IT-based er projects with these IoT benefits.

This approach seamlessly captures all the necessary resources for the project. Thanks to the experience and expertise of MicroNova partner and OpenGate® developer amplía, customers receive optimum support, regardless of the maturity of their IoT project – for long-term success at low cost.

<sup>1</sup> <https://www.machnation.com/2020/07/13/2020-iot-device-management-scorecard-rates-13-iot-platforms>



# Network Slicing: a 5G key technology

Besides new business models for network operators, 5G enables services and innovations that can optimize daily life. Network slicing provides the basis for this.

TEXT: Ingo Bauer PICTURE: © Iaremenko Sergii / Shutterstock.com

The special properties of 5G are creating far-reaching opportunities for innovation: Smart Industry, Smart Farming, Smart Cities, etc. As digitalization progresses and new areas are opened up for mobile communications, the number of connected end devices will quickly increase. Reliability and low latency thanks to ultra reliable low latency communication (URLLC), higher capacities through massive machine type communication (mMTC), and more security and high-speed connections using enhanced mobile broadband (eMBB) are all playing important roles.

At the same time, these technologies are presenting challenges for network operators and necessitating investments in the new network infrastructure. New approaches to network design and architecture are called for in order to respond to these requirements flexibly and with the necessary scalability. The appropriate technologies are available in the form of software-defined networking (SDN) and

network function virtualization (NFV) (see InNOVation 2-2020 for details of what MicroNova has to offer). In addition to these two, there are other key technologies for the 5G standard such as carrier aggregation, massive MIMO, beamforming, and network slicing. The latter – network slicing – which MicroNova is also already addressing in its further development of COM5 products, is discussed in more detail further on.

### How it works

Network slicing enables network operators to divide their existing radio access network (RAN) into so-called network slices. Such a slice is to be seen like a virtual, independent network that can be specifically adapted to the needs of the particular customer and made available to them. The basis for a service-oriented network can be created by also defining services and their quality. These include, for example, services in the field of smart homes or autonomous driving. As the roll-out of 5G technology progresses, slices can even be offered on a time and location basis, which saves costs.

This opens up a service- or application-oriented allocation of network resources for mobile network operators (MNOs), with a specific quality of service (QoS) for customers and end de-

vices. With network slicing, Vodafone expects that " ... in the future it should be possible for customers to pre-order 5G slices required for applications in a self-administration portal or 'shop system' for a specific location and a specific period of time. This means that on demand network connectivity for the next industrial revolution can be ordered with just a few clicks of the mouse. And at a lower price – a far cry from the investment that companies would have to make to provide a defined, high-quality network connection at the required location by other means."<sup>1</sup>

### Architecture

Conventional mobile technologies are based on a relatively rigid radio network that cannot be scaled for different use cases without consider-

able effort. While the further development of LTE technology already enables conditional scaling, for example via narrowband IoT (NB IoT), a great deal of "manual" effort is still generally required for network management – both for engineering and in operation.

Network slicing enables MNOs to map their network as independent, logical, isolated end-to-end segments on a physical infrastructure. By prioritizing network traffic or flexibly allocating the associated resources, it is possible to offer customers different SLAs (service level agreements, i.e. quality guarantees) and/or offer extensive customization. The basis for being able to offer such a range of services is the SDN/NFV architecture, which is what makes the concept of a highly flexible, dynamic, and scalable

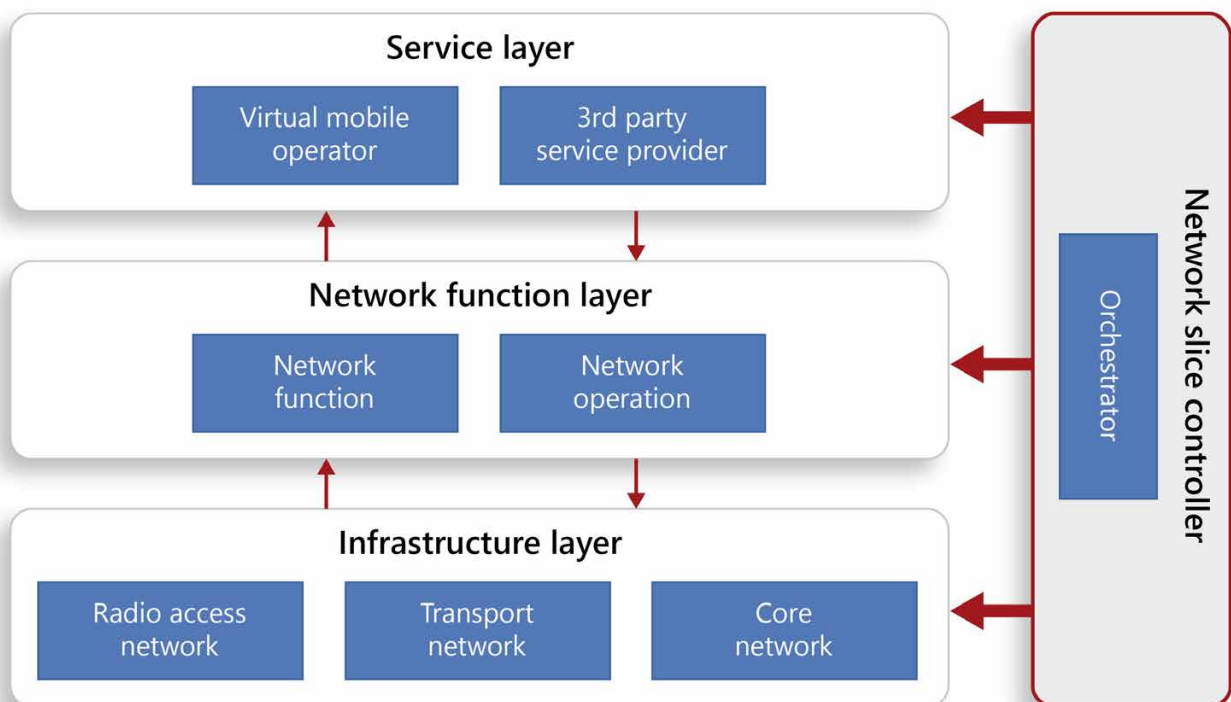

## 1 5G Architecture

<sup>1</sup> <https://www.vodafone.de/business/featured/technologie/wie-network-slicing-in-5g-netzen-nach-bedarf-bandbreite-latenz-und-dienstqualitaet-sicherstellt/>

network slice possible in the first place (see InNOVation 2-2020). The figure on page 21 shows a 5G structure with the different layers or network domains.

**Generic design of 5G network slicing network architecture**

The architecture essentially consists of two main blocks: one for slice implementation and one for slice management (slice controller). The first block for slice implementation comprises three layers: a service layer, a network function layer, and an infrastructure layer.

**Service layer**

The service layer provides the direct interface to the MNOs or virtual network operators (MVNOs) that share the underlying physical network. It provides a unified view of service requirements. Each service is formally represented as an instance. The service layer encapsulates all network properties in the form of SLA requirements that are expected to be fully satisfied by appropriate slice creation.

**Network function layer**

The network function layer is responsible for creating each slice in accordance with the service layer along with instance requests. It comprises network functions that represent defined behaviors and interfaces. Several such functions are placed and chained together through the virtual network infrastructure. This results in an end-to-end managed network slice instance (NSI) that mirrors the network properties requested by the service. Function configuration is accomplished through operations that enable management of the entire life cycle.

**Infrastructure layer**

The infrastructure layer forms the actual physical network topology (radio access, transport and core network) on which each network slice is mapped. It supplies the physical resources to host the various network functions that make up each slice.

**Network slice controller**

The network slice controller, or orchestrator, has interfaces to all layers and functionalities. As the central element,

it takes care of the management of each slice over its complete life cycle. Its main tasks are end-to-end service management and virtual resource management.

**Slice lifecycle**

An NSI is always considered end-to-end in the network, which is a key feature. An instance therefore includes all the necessary resources and functions, both physical (PNF - Physical Network Functions) and virtual (VNF - Virtual Network Functions), from the device to the air interface (radio) and through the backhaul and transport networks to the core network and management systems. Dynamic resource allocation in particular can also incorporate significantly more factors (e.g., traffic forecasts) with the help of AI or machine learning mechanisms (deep learning). The life cycle of an NSI is divided into four phases according to the 3rd Generation Partnership Project (3GPP, specification TS28.530):

**1.) Preparation:** This is where all key performance indicators (KPIs) relevant

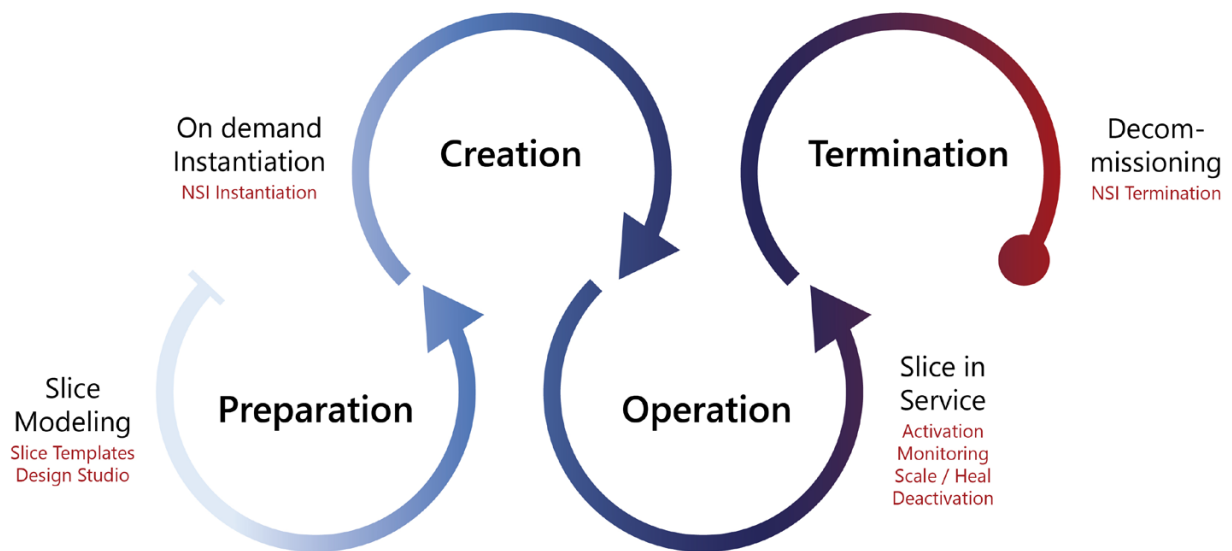

**2** NSI Lifecycle

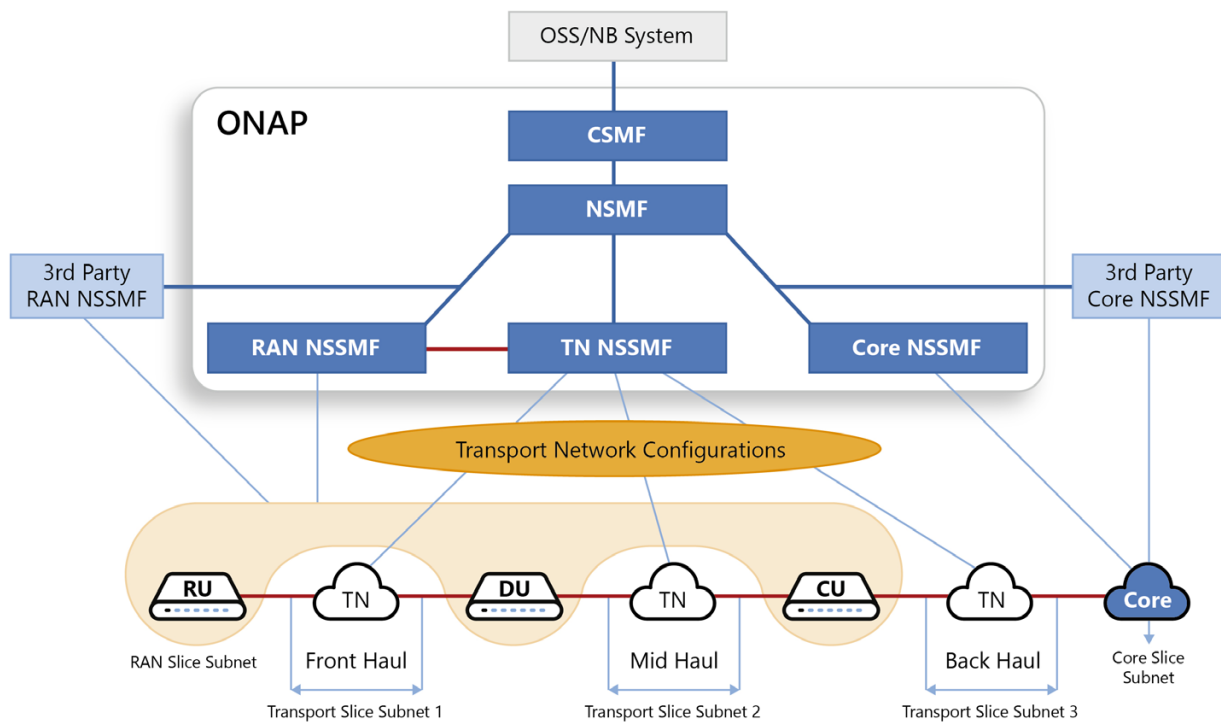

### 3 Slice Orchestrator

to the slice are defined. These KPIs describe the slice quality, capacity, class, design, etc. They also define the requirements for the network resources and serve as a guide for preparing and evaluating the network environment.

**2.) Commissioning:** This phase sees the creation of a slice instance, i.e. all required (network) resources from core to access are allocated and configured. These resources are distributed across different domains or subnets (core, x-haul, RAN), so the generic requirements must be mapped to the appropriate domain.

**3.) Operation:** The "Operation" phase includes activation and monitoring, KPI-based reporting, any necessary NSI adjustments due to capacity or topology changes, for example, and finally deactivation (terminates only the communication service, but not the NSI itself).

**4.) Decommissioning:** Decommissioning goes beyond deactivation and

means the complete removal of the NSI-specific configuration along with the release of associated resources.

The above high-level overview, based on the open source framework ONAP, explains the most important functional components as specified by 3GPP. It describes the key components of the slice manager or slice orchestrator:

- **Communication Service Management Function (CSMF):** Responsible for translating communications service-specific requirements into network slice-specific requirements for forwarding to the NSMF (see below). The CSMF also has a user interface (web portal) to allow the complete creation and management of network services or slices.

- **Network Slice Management Function (NSMF):** Controls the management – including the life cycle – of NSIs. It infers requests sent to the network slice subnet from the require-

#### MicroNova portfolio in the field of SDN/NFV

MicroNova combines extensive expertise in AI/ML, many years of experience in automating and optimizing processes in radio network design, extensive cross-technology mobile knowledge, as well as access to a fully open source-based ecosystem (OSNL). This results in broad solution expertise that benefits network operators and our customers. Intelligent resource allocation, automated forecasting of required network slices and load balancing are just a few examples.

ments of the network slice. In addition to the CSMF interface, it has interfaces to the corresponding subnet management functions (NSSMF) for RAN, transport and core. The NSMF also handles the partitioning into subnet slices and their orchestration to form the NSSMFs (see below), which in turn is based on the relevant slice design templates (SD templates).

- **Network Slice Subnet Management Function (NSSMF):** The NSSMF, also known as the SDN Controller, is responsible for managing and orchestrating (including life cycle) NSIs. This function also establishes the relationship between the single slice service (Network Slice Selection Assistance Information, or S-NSSAI) and the NSI. NSSMFs are available for each slice subnet (RAN, transport, core). These can also be developed and integrated by third-party vendors, allowing direct integration of legacy networks (e.g., 4G).

- **Network Function Management Function (NFMF):** This is responsible for the application level management of VNFs and PNFs and also provides the "NF provisioning service", which in turn includes configuration management (CM), fault management (FM) and performance management.

#### Network slicing and KPIs

The table below describes the 5G standard KPIs according to ITU-2020 of the ITU<sup>2</sup> including mapping to the 3GPP service classes. This serves as the basis for defining a "virtual" network slice that ultimately supplies the provider or recipient of a service with the service or network slice from the eMBB, mMTC and URLLC classes.

The following diagram presents these key figures in graphic form and enables appropriate monitoring.

The standardization and further development of 5G and the next-generation networks are discussed and promoted in various bodies around the world, such as 3GPP, ITU, ETSI, O-RAN Alliance, and NGMN. Various use cases are implemented and tested, and existing ones are further developed and new ones specified, in connection with a large number of research projects.

Network slicing is the decisive key technology of 5G for mapping the multitude of new services in the network – while at the same time making effective and cost-efficient use of available resources. This enables more and higher-performance data traffic and ultimately paves the way to the service-oriented network or NSaaS (network slicing as a service) – for an even more revenue-generating mobile portfolio. The essential prerequisite for network slicing is a fully integrated, automated SDN architecture. Open source solutions and platforms, such

KPI / feature	Description	Requirement	5G use case
Peak data rate	Maximum data rate to be supported	20 Gbps	eMBB
User experienced data rate (perceived data rate)	Data rate that should be available for the user experience 95% of the time.	100 Mbps	eMBB
Latency	End-to-end packet delay	4 ms 1 ms	eMBB URLLC
Mobility	Maximum speed for hand-off and QoS	500 km/h	eMBB URLLC
Connection Density	Total number of devices per area unit	10-6 / km <sup>2</sup>	mMTC
Energy Efficiency	Energy consumption of data transmitted / received per unit (device or network)		eMBB
Area Traffic Capacity	Total traffic in service area	10 Mbps/m <sup>2</sup>	eMBB
Peak Downlink Spectrum Efficiency	Throughput per unit, radio bandwidth and network cell	30 bps/Hz	eMBB

#### 4 KPI definition according to ITU-2020 with mapping to 3GPP service classes

<sup>2</sup> International Mobile Telecommunications-2020 from International Telecommunication Union



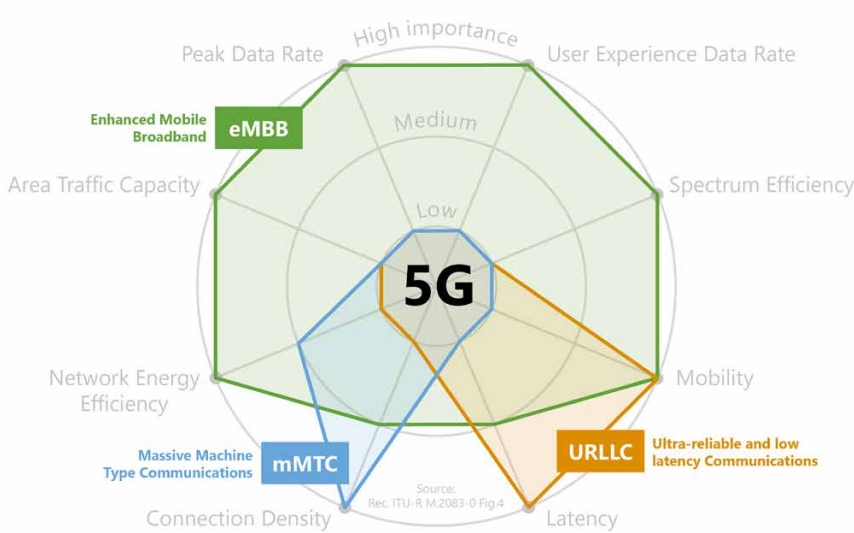

**5** Network Slicing KPIs at a glance

as ONAP, are also playing an increasingly important role here for network operators. In addition, AI/ML-based approaches are becoming increasingly important for telecommunications providers (see article on page 30).

**Summary**

The many years of experience in the area of automating network setup and network operation processes for two of the three German mobile network operators through COM5.Mobile, the continuous development/expansion of expertise in the area of AI/ML, as well as access to a completely open source-based ecosystem (OSNL) through its collaboration with 5G BERLIN e. V., all enable MicroNova to incorporate the benefits associated with network slicing technology into its complete portfolio of telco solutions.

**ONAP**

The Open Network Automation Platform provides a comprehensive foundation for orchestrating, managing and automating network and edge computing services for MNOs, cloud providers, and businesses using related services. Real-time, policy-driven orchestration and automation of physical, virtual, and cloud-native network functions enable rapid automation of new services, as well as full lifecycle management critical to 5G and next-generation networks.

ONAP has been operating since 2017, as a result of the merger of the Open-ECOMP (AT&T) and Open-Orchestrator (Open-O; Linux Foundation with China Mobile, Huawei and ZTE) projects. The Linux Foundation specifies different use cases, so-called blueprints, such as E2E network slicing or SON. ONAP's members include not only these founders, but also other telco companies, network equipment suppliers, and hardware and software manufacturers.

It has become the most important platform for network automation and orchestration thanks to its members' strong commitment. Ten million lines of code testify to a distinctly high level of complexity, yet the modular structure based on a micro service architecture and runtimes in Docker containers facilitates easy functional extensions.

The portfolio ranges from the automation of radio network-specific use cases such as site integration to network optimization using its COM5.Mobile products. Similarly, the COM5.SDN Mediator can be used to integrate an existing network into a leading-edge SDN architecture. Furthermore, this subject also includes the integration and management of the specific network and service design or slice templates in the form of policies all the way through to the integration of functional components in the form of micro services.



# Maximize Network Coverage: Grey Spot Sharing

German mobile communications providers are closing several thousand “grey spots” for their customers in the 4G network – and they are doing so by sharing active network technology with each other.

TEXT: Georg Kieferl PICTURE: © yougoigo / Shutterstock.com

Not all operators have the same network coverage today, especially away from main traffic routes. This creates what are known as grey spots – areas where not all providers can offer their customers mobile network access via 4G. It is often an economic challenge for mobile network operators (MNOs) to build their own infrastructure in these less frequented areas and operate it using their own network technology. Grey spot sharing, i.e., the use of a partner’s active infrastructure in its own network gaps – is now intended to remedy the situation. This will be possible thanks to a new technological

approach in the networks. The MNOs will thus offer all customers 4G access on the 800 MHz frequency band.

Operators launched a number of initiatives for better network coverage in the past. To this end, Telekom, Vodafone and Telefónica concluded an agreement in principle to open up previously completely unserved areas, so-called “white spots,” for almost 6,000 new sites in fall 2019. Each MNO was to build a share of the passive network infrastructure and grant the other parties the right to use it. In contrast to the new initiative, only the

structural infrastructure such as radio masts and power supply was shared; the transmission technology and antennas were provided independently by each operator.

## No separate wireless technology

Unlike previous collaborations such as site sharing or operator agreements to close white spots, grey spot sharing does not require the installation of separate radio technology or additional antennas. All three telecommunications companies will open up their



mobile communications networks to competitors only in those areas of Germany where their own networks do not offer reception.

It was to be expected that the Federal Network Agency and the Federal Competition Authority would have a say in the matter. The MNOs therefore involved the regulatory authorities from the outset; it had already been indicated in other contexts that greater cooperation between competitors was entirely desirable in the interests of better coverage. As a general principle, the Federal Competition Author-

ity welcomes cooperative ventures to improve network coverage as long as they do not suppress competition.

#### How it works

The technical basis for grey spot sharing is the "MOCN feature" (multiple operator core network) for RAN sharing. This means that a radio access network (RAN) is connected to multiple core networks. The active radio technology of the operator best positioned in the area in question is used. The configuration management system – i.e. COM5.Mobile from MicroNova – must read in and match the cell configuration of the mobile network providers involved. So if, for example, Telekom wishes to share its network with Vodafone, the cells concerned must be treated by Vodafone as its own cells.

COM5.Mobile thus has the task of accessing external configuration data from Telekom and integrating this information transparently into Vodafone's database. This is not a one-off process, but a permanent one, as changes have to be incorporated on an ongoing basis. As a result – in this example – the external cells are considered to be Vodafone's own and are taken into account in neighbor and frequency management.

#### End-user benefit = MNO benefit

What do users notice about this on their smartphones? A mobile station approved for grey spot sharing identifies itself to the devices using the IDs of the network operators involved, thereby allowing phones, smart-watches, etc. to easily log into the network in question. The benefit for customers is obvious: they notice practically nothing when they are

switched to the mobile network with the best availability. They appear to operate on their contractual partner's network regardless of which company actually operates the mobile station in question. The MNOs naturally benefit in terms of customer satisfaction and hence also customer loyalty.

Grey spot sharing is exclusively about 4G LTE connectivity; the new and significantly faster 5G mobile network will continue to be built and operated separately. According to the latest Broadband Monitor, all network operators together – Telekom, Vodafone, and Telefónica O2 – currently cover 96.5 percent of Germany with 4G. The benefits of the cooperation are obvious – first and foremost the low costs – as they can be realized without the installation of new antennas or new technology.

#### 5G – Single-handed

Network providers are each rolling out their faster 5G network on their own. On average, Telekom and Vodafone 5G users can achieve data rates of between 460 and 500 Mbit/s, provided the 5G smartphone used supports the frequency range around 3.6 GHz and the faster 5G version has been deployed. However, the N78 band with that 3.6 GHz has only a short range and is therefore rarely found, even in cities with 5G coverage. Grey spot sharing will therefore continue to be an important element of coverage for the general population, especially for rural areas, due to the limited 5G range. Here, as with other mobile issues, MicroNova provides comprehensive support for MNOs with its COM5.Mobile and COM5.SDN products.

# Interview with: Alexander Seitz (Telefónica Germany)

Alexander Seitz (Dipl.-Ing.) is Head of Access Network Design, Performance and Optimization at Telefónica Germany GmbH & Co OHG in Munich. In this interview he talks about network optimizations with a view to COM5.Mobile, which resulted, among other things, in the top grade "very good" in the major annual mobile network quality test done by Connect, a renowned German specialist journal

**TEXT:** Editorial staff **PICTURE:** © Have a nice day Photo / Shutterstock.com

**InNOVation:** Mr. Seitz, how was Telefónica Germany able to improve the ongoing optimization process of the Radio Access Network with COM5.Mobile Optimizer?

**Alexander Seitz (AS):** The simplifications that came with COM5.Mobile Optimizer allow us to work very closely to the live network. This means that at any time we can reliably determine the parameter values in our network. In particular, we can also ensure that any changes are applied to the network promptly and remain there exactly as we have configured them. Above all, this has significantly improved the time-to-market.

**InNOVation:** How exactly has the Parameter Designer module in COM5.Mobile Optimizer improved the time-to-market?

**AS:** This is evident in two aspects: For one, we were able to improve the processes thanks to the proximity of COM5.Mobile Optimizer to the live network to such an extent that we now have a very prompt activation of site-specific optimizations. More importantly, however, we also have to adapt network-wide specifications promptly ourselves and now we no longer need to develop the software to do this. We are therefore able to test new design specifications first in a small region and then activate them directly throughout the network in a short time, without having to wait for new releases of COM5.Mobile. This also eliminates the need to package changes; we get feedback on changes immediately that can be clearly attributed to a de-

sign change. We are in a full CI/CD process here in network design.

**InNOVation:** What are you expecting from the Fastlane and ZeroTouch features of COM5.Mobile Optimizer?

**AS:** Above all, the process of site-specific optimizations will improve. For some optimization cases, we cur-

rently still use the NMS solutions from the system technology vendors to directly see the customer impact, and we then maintain the optimal value in COM5.Mobile. Of course this process is time-consuming and becomes unnecessary with FastLane and ZeroTouch. The process is further simplified and we reduce possible errors with the universal use of COM5.Mobile. Moreover, this allows us to relieve the burden on our network operations, so that our team can respond to other time-critical matters more quickly and with more flexibility.

**InNOVation:** How does COM5.Mobile Integrator support you in the roll-out process and what are your expectations of COM5.Mobile Integrator's Parameter Designer?

**AS:** By introducing COM5.Mobile Integrator, we have already taken a big step towards being able to create integration files on demand and shortly before integration. This has eliminated many potential sources of error. With the Parameter Designer, we will be able to design the process chain for changes completely independently of the release cycle, just like in COM5.Mobile Optimizer. In this way, we can drastically reduce the risk of errors as well as further reduce our time-to-market, especially for the introduction of new hardware components.

**InNOVation:** How can COM5.Mobile support you as you move toward SDN/NFV and where do you see the advantages of a fully automated solution for future topics like SDN/NFV?

**AS:** In recent years the COM5.Mobile software architecture has evolved from a specialized approach with dedicated use cases to a flexible platform. We are now at a stage where we can automate this platform. In this way, we are also creating the foundations to allow us to carry out network services and configurations on demand and fully automatically. In the future, we will see a further decoupling of hardware and software, not just in Open-RAN. As advantageous as this decoupling is, it is also important to ensure holistic service provisioning here. The flexibilization and modularization of COM5 Mobile is going in exactly the right direction.

**InNOVation:** Mr. Seitz, thank you very much for your time.



*„By introducing COM5.Mobile Integrator, we have already taken a big step towards being able to create integration files on-demand and shortly before integration.“*

**– Alexander Seitz,  
Telefónica Germany GmbH &  
Co. OHG**

# Into the Mobile Radio Network with AI

With the extension of 5G technology, new network solutions are in demand – incorporating artificial intelligence (AI) into the radio network helps to make this a reality.

TEXT: Ella Schmidtobreick PICTURES: © metamorworks / Shutterstock.com; © telmanbagirov / Fotolia.com

The large-scale roll-out of the 5G network is not only bringing many benefits, but a few challenges too. For example, not all new services can be implemented with the technologies currently in use. MicroNova therefore relies on AI-based methods to analyze the network data managed via COM5.Mobile and implements corresponding functions in the new COM5.SDN product generation.

## Limits of the current network

The radio network is becoming ever more complex due to the constantly increasing number of devices requesting access to it. In the future it will not just be smartphones accessing sites, but also various vehicles, machines, and so on. In addition, it will become increasingly important for future services to be executed in real time. For example, cars will have to be able to send and receive real-time information. Otherwise, the time lag will be too great to react appropriately to changing circumstances.

In addition, the quantity of data that needs to be processed is growing, not only because of the numerous devices that access the network, but also because the data being transmitted is becoming more and more complex, such as video streams. In order to be able to ensure a fast and agile network in the future, the use of AI is essential – because artificial intelligence opens up possibilities to overcome the aforementioned limitations.

**Advantages of using AI**

The use of AI in the telecommunications industry brings far-reaching benefits. The two key application areas for mobile network operators are Service Assurance, and optimization of their existing networks.

**Service Assurance**

The essential task of a network operator is to ensure a stable mobile network. If the network is not permanently available with sufficient bandwidth, customers will gradually switch to better performing competitors. To avoid this, every network operator must ensure its services are performing consistently. This is primarily achieved by predicting the upcoming data volume as reliably as possible and by detecting cyber attacks at an early stage.

**Prediction**

The biggest advantage of using AI within the Radio Access Network (RAN) is the ability to predict future data volumes. This involves incorporating data generated both inside and outside the RAN. This means, for example, weather forecasts or the match schedule of the national football league can be included in network planning. What is designed is not just a forecast of the expected utilization, but also the ap-

propriate positioning and dimensioning of antennas and nodes. The more precise planning, now also based on external data, results in better resource allocation and utilization in order to offer all users the best possible Quality of Experience (QoE).

Furthermore, on demand services and ultra-reliable low-latency communication (URLLC) can only be offered with the help of AI. These require both low latency and a very low error rate. To ensure this, faults must not occur in the first place – and must be detected in advance with the help of AI. To do this, conspicuous patterns before an imminent failure are identified and compensated for by a rapid redistribution of resources. But this requires a network that will be much more flexible in the future. This approach means that potential faults do not affect the end user, and all services are available without interruption.

**Security**

Another important aspect of Service Assurance is the early detection of cyber attacks. The introduction of new services also requires adapting the existing network architecture. Software Defined Networking (SDN) is primarily used here, whereby hardware and software are decoupled from each other. As already mentioned in the previous issue of InNOVation (02-2020), the core element of this structure is the orchestrator. Thanks to its central position, it has a comprehensive overall picture of the complete RAN, so that it immediately detects anomalies through the use of AI. Consequently, both the prediction and the innovative architecture itself contribute to the resilience of the entire mobile network by enabling the early detection of irregularities.

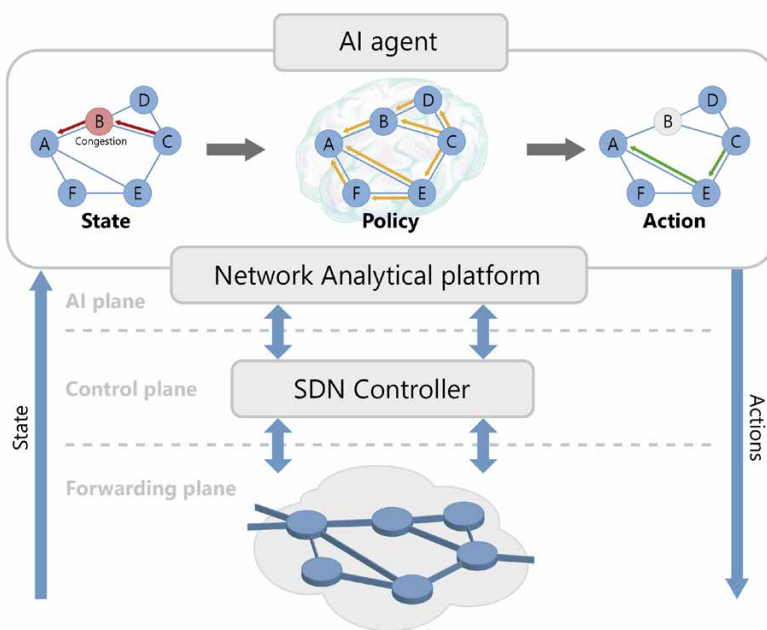

**1** Possible application of AI in a Software Defined Network (SDN).

**Optimization**

Next to Service Assurance, optimization of the existing network is the most fruitful approach. Network operators can achieve this in various ways. AI also plays an important role here.

**Automation**

Automation within the mobile network plays a central role. Over time, more and more routine interventions will be carried out by machines. AI will understand more contexts on its own and make decisions itself on this basis. This means that in the future, networks will increasingly find solutions to complex problems on their own, gradually optimize themselves, and find approaches that experts have so far not considered. The result will be their reacting more and more quickly and efficiently to unknown situations, saving a lot of working time and reducing the risk of errors in manual optimizations – in summary, the ultimate result will be lower costs and a better network.

**Time-to-market**

Within the network, however, it is not only the ongoing processes that are optimized: The integration of AI will also significantly simplify and accelerate network roll-outs. Thanks to SDN, network operators no longer have to replace the hardware at considerable

cost in every implementation phase – a simple software update is sufficient. This significantly shortens the time until new services and network configurations are available and therefore increases revenue.

**AI integration**

The topic of AI is a broad field. In the telecommunications industry, it is primarily the sub-discipline of machine learning (ML) that is used, in which the system learns to recognize patterns and to assign unknown data on the basis of such patterns. The myriad parameters within a radio network provide an ideal basis for training ML models. It is important to choose the right model. Due to the complexity of both the data involved and the models, this can be quite a challenge. All forms of ML are used in the telecommunications industry:

- » Supervised learning
- » Unsupervised learning
- » Semi-supervised learning
- » Reinforcement learning

**Training**

All of these learning methods require prior training so that systems can later make decisions in the desired way. In some cases training data is required,

on the basis of which the model learns. Test data is also required, in order to check how good the decision-making ability of the model already is.

However, if too little information is available, the model cannot learn the correlations sufficiently well and the hit rate for correct decisions is too low (underfitting). On the other hand, if the model is provided with too much data the opposite occurs, known as overfitting. In this case the model gradually learns the properties of the datasets by heart, and only recognizes in a useful way information that is already familiar, while it struggles to classify new data appropriately.

To avoid this, both training and test data should be available and initially be unknown to the model. Using this data, measurements are taken at regular intervals to see how often the model makes correct decisions and whether further training is necessary. The requirements in this regard can be quite different.

**Supervised learning**

In supervised learning, the model learns on the basis of 'labeled' data: Before training begins, the data is labeled manually with the correct result. The decision made by the model

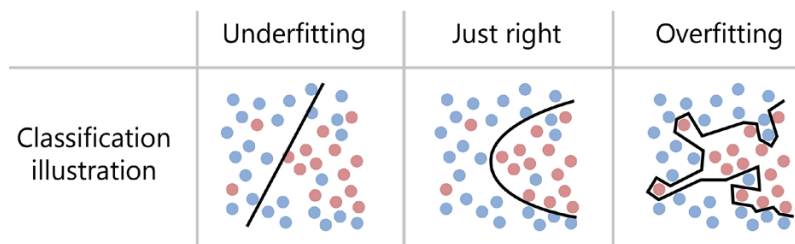

**2** Principle of underfitting and overfitting



## Supervised Learning

### Classification

- » Service requirements
- » Operational data
- » Data traffic

#### Example:

- > Support Vector Maschine
- > Neural Networks

### Prediction

- » Data volume (esp. traffic peaks)
- » Untypical usage behaviour (Fraud prevention)
- » Quality of experience
- » Customer satisfaction
- » Connection errors

#### Example:

- > Predictive Maintenance

after processing the respective input is compared with this label. If the assignments do not match, a step-by-step adjustment is made. In this way, the model continuously improves and, after training, correctly recognizes a large number of unknown datasets.

A classic use case for supervised learning in the telecommunications industry is the classification of service requests, operational data, or data traffic. Frequently used methods include, for example, Support Vector Machines, Artificial Neural Networks, or Deep Neural Networks. Such neural

## Unsupervised Learning

### Clustering of data

- » Nodes
- » Users
- » Devices
- » User data

#### Example:

- > k-Means Clustering
- > Principal Component Analysis

### Customer profiling

### Anomaly detection

- » Traffic analysis
- » Network monitoring
- » Security

networks are used to realize various machine learning methods, including supervised learning. The structure of neural networks is, as the name suggests, based on the neuronal structure of the human brain. The different layers consist of several nodes, each of which is linked to nodes from the previous and subsequent layers.

Only the input and output layers are visible from the outside. The multi-level decisions are made in the intermediate, hidden layers. Here, the connections between the individual neurons are assigned random weights

## Reinforcement Learning

### Reconfiguration of network parameters

### Decision making for dynamic resource control

at the beginning. These are optimized through training by means of backpropagation – a form of error feedback following the delta rule. In this way, the neural network learns and makes the desired decisions in the end.

Another important field of application for supervised learning is the prediction mentioned above. This involves predicting expected data volumes, as well as traffic peaks or atypical usage behavior, for example to prevent telephone fraud. The correct prediction of possible connection errors can be used for predictive main-

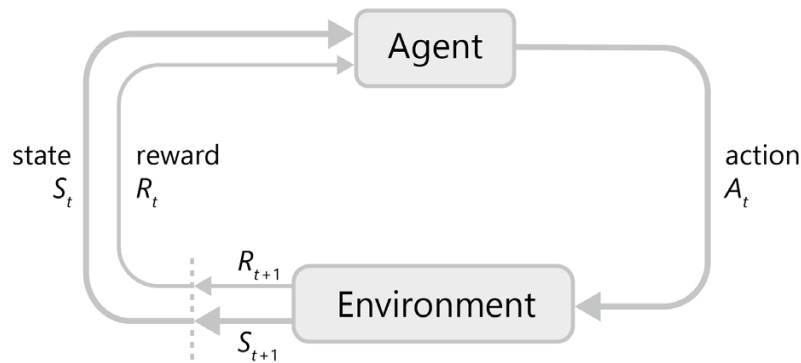

### 3 Principle of reinforcement learning

tenance, so that potential sources of error can be eliminated before they occur. In addition, prediction enables forecasts about user behavior, quality of experience, and customer satisfaction – and continuous improvement of services as a result.

#### Unsupervised learning

In contrast to supervised learning, unsupervised learning does not use data that has already been labeled for training. The model does not at any time know whether the final decision is right or wrong. It relies exclusively on independently recognized patterns and correlations that occur between the training data, and makes its decisions on this basis. This type of machine learning can be particularly helpful if it is not possible to label the data, for example for resource reasons. Particularly with large amounts of data, prior assignment is very time-consuming, which is why it is often skipped.

Two important mathematical models that are used in unsupervised learning are the k-means algorithm and principal component analysis. Both methods focus on the classification of data into several groups based on their mean deviation. The methods are used in

clustering nodes, end users, and devices, as well as various types of user data. They are also helpful in creating customer profiles and recognizing irregular behavior. The latter promotes security and supports network monitoring.

#### Semi-supervised learning

To avoid the laborious labeling work, often only a small part of the data is categorized. This results in a hybrid form of supervised and unsupervised learning, referred to as semi-supervised learning. After an initial very effective but also cost-intensive training with the labeled datasets, the model is then further developed with the unlabeled data.

This approach results in a good mix of initial effort and return. Both traffic classification and anomaly detection are important application areas. The latter is achieved primarily through the analysis of data traffic and comprehensive network monitoring.

#### Reinforcement learning

In contrast to the previous models, reinforcement learning does not use data generated in advance. An agent

is placed in an environment predefined by a Markov decision process and performs actions independently. The goal is to induce the agent to perform an optimal combination of actions by means of a reward strategy based on maximizing the expected return. By continuously interpreting the autonomous movements, the agent is constantly exposed to new states and receives positive or negative rewards. In this way it learns which actions increase its reward function and performs them more frequently in order to reach the goal.

What is special about reinforcement learning is that the model learns without concrete instructions and often finds creative ways to solve problems on its own. This type of ML is used in the telecommunications environment primarily for reconfiguring network parameters and for formulating dynamic policies for resource management. In both cases, the environment plays a major role. For example, the configuration depends not only on the cell neighborhoods; consideration must also be given to the surrounding buildings and vegetation.

**Conclusion**

The use of AI is essential for future innovations in the mobile communications environment. Many of the planned functions of the 5G network, for example, cannot be realized without prediction and agility, and therefore the integration of AI. Network operators will have to get to grips with the various strategies in the field of machine learning in the near future; MicroNova can provide comprehensive support here. Because a successful combination of algorithms and training data creates the basis for a high-revenue and high-profit future.



# ManageEngine expands its portfolio

Network monitoring for IT service providers and protecting Microsoft 365 environments: These are the two key aspects of the new ManageEngine solutions.

**TEXT: Editorial staff PICTURES: © DKosig / iStockPhoto.com; © ManageEngine**

## Network monitoring for Managed Service Providers (MSP)

ManageEngine has developed "OpManager MSP", a solution for network, server and virtualization monitoring that has been designed specifically for the requirements of IT service providers. Managed Service Providers can use this new solution to easily and cost-effectively monitor the performance, health, and availability of customer networks they manage, all from a central console.

Like all of ManageEngine's MSP solutions, OpManager MSP features a multi-tenant architecture that allows MSPs to organize and manage the network activities of several customers in parallel. This allows IT service providers to remotely analyze problems at any location and update network configurations as required without needing a local administrator.

Custom dashboards provide a quick overview of a specific network. They quickly and clearly summarize key information such as performance, bandwidth consumption, and recent changes to device configurations.

## Protection and security for Microsoft 365

The new security solution "M365 Security Plus" enables enterprises to secure their Microsoft 365 environment (formerly Office 365). ManageEngine has developed extensive auditing and monitoring functions for this purpose, which offer additional protection against unauthorized access and cyber attacks.

IT administrators can use the solution to immediately detect critical changes and activities related to Exchange Online, Teams or other Microsoft 365 components through real-time alerts. M365 Security Plus also

monitors the status and performance of the entire Microsoft 365 environment.

A content-based search helps with early detection of phishing attacks. In addition, M365 Security Plus offers further functions that aid the detection of spam and malware, as well as the delegation of simple tasks to non-administrators.

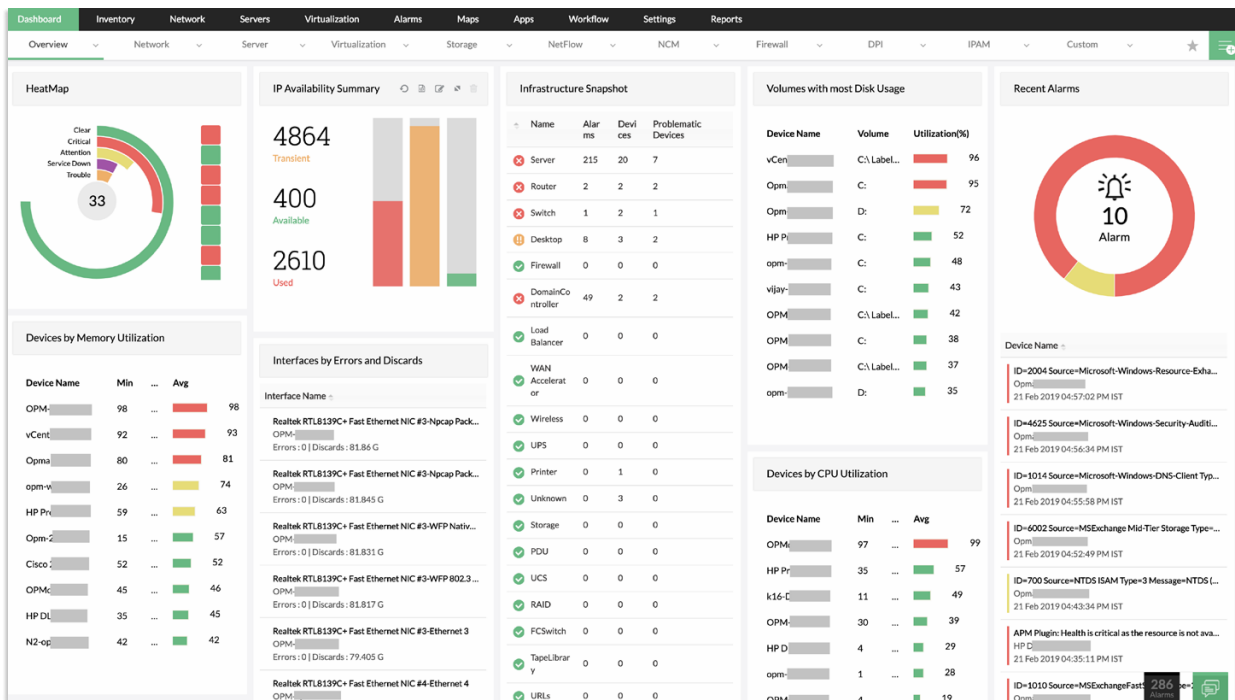

**1 OpManager MSP Dashboard:** Custom dashboards show IT service providers all key information about a specific network at a glance. This makes it possible to quickly find out what is causing problems – and take remedial action before end users notice anything.

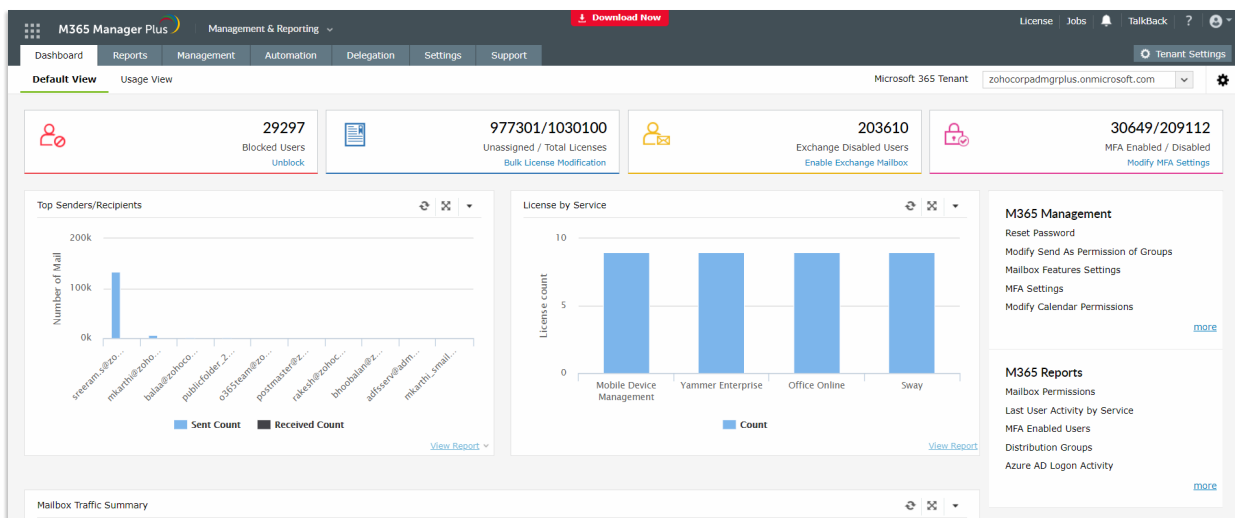

**2 M365 Security Plus Dashboard:** Here, IT administrators can find all important information about Microsoft 365 licenses, users, mailbox traffic, etc.

**Free trial versions**

Further information on the products presented here and the free 30-day trial versions are available from the following links:

- » **OpManager MSP:** <https://www.manageengine.de/opmanagersmp>
- » **M365 Security Plus:** <https://www.manageengine.de/m365securityplus>

# Enterprise Mobility Management for Bay Logistik

Mobile Device Manager Plus simplifies mobile content delivery

TEXT: Editorial staff PICTURE: © Bay Logistik

## Bay Logistik GmbH + Co. KG:

- » Sector: Logistics
- » Employees: approx. 220
- » Head office: Waiblingen
- » Established: 1945

Bay Logistik GmbH + Co. KG is a family-owned services company specializing in the transport and storage of liquid and granulated chemicals. Established in 1945, the company focuses on transparency and quality throughout the entire supply chain. Bay Logistik's perfectly synchronized transport services, which are created in close cooperation with the respective client, allow customers to reduce the cost-intensive provisioning of raw materials to a minimum or outsource it completely.

## High expenditure of time and lacking overview

In order to ensure that the shipments throughout Europe can always be handled reliably and flexibly, the company attaches great importance to providing the best possible support to its drivers and the on-board technical equipment. Each of its 150 trucks is equipped with a tablet that contains all the important information – from dispatch orders, loading information and messages to/from the dispatcher, to fuel reports, tire pressure data, mileage and positions, through to all other data needed to ensure seamless operations.

Bay Logistik's IT department relied on several stand-alone solutions to manage these endpoints. To keep the apps up to date, they had to be updated individually and sometimes

multiple times. Compatibility checks for operating systems and applications were also very time-consuming in the previous tools, especially for enterprise apps. Since the apps also had different license periods, IT manager Simone Hofmeister had to spend a great deal of time keeping track of everything.

Time-consuming endpoint management and the lack of an overview of licenses prompted the company to look for a new Enterprise Mobility Management solution. "We wanted to be able to manage all mobile endpoints quickly and easily in one portal solution and at a glance," explains Simone Hofmeister. After extensive research, the IT department tested Mobile Device Manager Plus from ManageEngine – and was already convinced during the 30-day free trial period that they had found the right solution.



### ManageEngine's Mobile Device Manager Plus

"With Mobile Device Manager Plus, we can keep all devices up to date. Moreover, profile management prevents settings accidentally being made in the apps or apps being deleted," says the IT manager. To give drivers a clearly structured overview of the apps they need to do their job, Bay Logistik uses the ManageEngine solution's "kiosk mode": this reliably prevents unintentional system changes that could lead to an app or tablet failure.

The testing of the enterprise apps has also become easier for the IT department: The applications can be beta-tested and then rolled out to the respective groups or endpoints.

Another advantage is the possibility of providing documents centrally on the tablets. This allows the dispatch department and the in-house workshop to send important information such as damage reports, customer receipts or approvals to one or more drivers at the same time. In this way, the documents are exactly where they should be: with the driver and therefore also directly with the customer. "The straightforward dispatch of documents helps us to present our digitalization progress and our quality thinking 'as an aside' directly to our customers," Simone Hofmeister is pleased to say.

The containerization used for content management has also significantly simplified smartphone management: new devices can now be easily integrated as BYOD so that they can also be used for employees' personal purposes. If a phone is lost or an employee leaves, the IT department can quickly and easily delete all company data and documents using the "Corporate Wipe" feature in the Mobile Device Manager Plus console.

### Less workload, lower costs

Besides added security, this built-in remote access has another advantage: Bay Logistik was able to stop using another stand-alone solution and further reduce IT costs. "In addition to the noticeable reduction in workload, with Mobile Device Manager Plus our IT team has less administrative workload and an intuitive all-in-one solution for our devices," explains the IT manager.

### Secure digitalization for seamless shipments

Mobile Device Manager Plus has reduced the workload of Bay Logistik's IT department within a very short space of time. "The solution contains a variety of features that we will try out over time and implement as appropriate. We have already achieved our first goal – the secure digitalization and equipping of the fleet with the 150 tablets," says Simone Hofmeister with satisfaction.



*"In addition to the noticeable reduction in workload, with Mobile Device Manager Plus our IT team has less administrative workload and an intuitive all-in-one solution for our devices."*

– Simone Hofmeister,  
IT Manager,  
Bay Logistik GmbH & Co. KG

### Customer benefits:

- » Save time on routine tasks
- » Intuitive and user-friendly
- » One central tool for the most diverse requirements
- » Excellent price-to-performance ratio
- » More resources for more important issues



# IT-Security – sysbus.eu talks with MicroNova

Dr. Götz Güttich, Editor-in-Chief of the IT information platform sysbus.eu, spoke with Julia Reuter from MicroNova about IT security and data loss prevention – here is the interview.

TEXT: sysbus.eu PICTURE: © matejmo / iStockPhoto.com

## About sysbus.eu

[www.sysbus.eu](http://www.sysbus.eu) is a German-language information portal aimed primarily at IT specialists and decision-makers. Sysbus, established in 2008, regularly provides its audience with news, technical background information, tests and expert commentary.

**sysbus:** With the rise in home office solutions due to the coronavirus pandemic, there is also more talk about the associated security problems. What is your position on this?

**Julia Reuter (JR):** It is a valid worry that the number and intensity of attacks will become even more intense given the work from home situation. Simultaneously, the risk that employees are or become careless also increases. We are therefore continuing

to focus on the issue of data loss prevention, which we believe has become much more important in the wake of the coronavirus pandemic. Think cloud protection, instant messaging and web uploads and network shares. This also applies to the application level relating to Microsoft 365 services and especially Microsoft Teams, which is now so ubiquitous. It is frightening that there is so much talk about data protection in the sense of the GDPR, but so little about how users handle data.





**sysbus:** DLP solutions are mainly of interest to enterprise level companies, aren't they?

**JR:** In fact, small and medium-sized enterprises are often affected by data loss. A study\* from BITKOM, Germany's leading IT association, revealed that indeed 75 percent of companies were victims of data theft, industrial espionage or sabotage in 2018 and 2019. And it was most frequently companies with ten to 99 employees that

were affected. The data is from the period before the coronavirus, but with more and more people working from home it is likely the situation has become worse. In the past, cost was often an obstacle for SMEs but this is no longer an exclusion criterion – neither in terms of licensing nor running costs, because modern DLP solutions, such as that from Safetica, are no longer so complex.

**sysbus:** What do you think will happen in the security sector during this year?

**JR:** Even if companies are able to return to some normality during the year, I think that working from home will become more of a permanent phenomenon than before the pandemic. It has become part of the 'new normal'. We very much hope that in particular SMEs with no dedicated IT security team will continue to raise awareness among their employees accordingly. It is a truism that individuals in companies remain the primary gateway inside. A good data loss prevention solution can go a long way of course, but the appropriate awareness is simply irreplaceable. It's like a car: just because we have airbags, ESP, etc., doesn't mean we can drive around with our eyes closed.

**sysbus:** What developments can be expected in your company in this context?

**JR:** In any event, we can already see that inquiries about our data loss prevention services are on the rise. Many companies have recognized the need to take action in this regard. We have trained our team to be able to respond to inquiries in connection with home working, coronavirus and so on. In addition, MicroNova is also setting up

a partner program for Safetica's DLP products in 2021. Taking the role of distributor, we would like to attract some strong resellers for partnerships. It is particularly important to us that partners are both IT security-savvy and familiar with the needs of small and medium-sized enterprises.



*„In the past, cost was often an obstacle for SMEs but this is no longer an exclusion criterion – neither in terms of licensing nor running costs, because modern DLP solutions, such as that from Safetica, are no longer so complex.“*

– Julia Reuter,  
Business Developer  
Enterprise Management,  
MicroNova AG

\* [www.bitkom.org/sites/default/files/2020-02/200211\\_bitkom\\_studie\\_wirtschaftsschutz\\_2020\\_final.pdf](http://www.bitkom.org/sites/default/files/2020-02/200211_bitkom_studie_wirtschaftsschutz_2020_final.pdf)

# Three Tips for Successful Project Management

Project management is as important as it is unique.

Our team has developed some tips based on three concrete scenarios – which can easily be implemented with monday.com.

TEXT: Julia Reuter PICTURES: © GaudiLab / Shutterstock.com; © monday.com

## Scenario 1: Preparing visualizations for meetings automatically

Whether it's weekly meetings with line managers, the monthly jour fixe with the Board, or the quarterly review with external stakeholders – before such meetings, project managers usually spend a lot of time preparing PowerPoint slides to be presented, or finding and preparing the relevant facts and figures.

**The goal:** To create clear, informative, and intuitive project dashboards with just a few clicks – to centralize data and information.

**The solution:** Tool-based automation! With 15 different dashboard widgets, monday.com offers extensive templates that make it easy to track

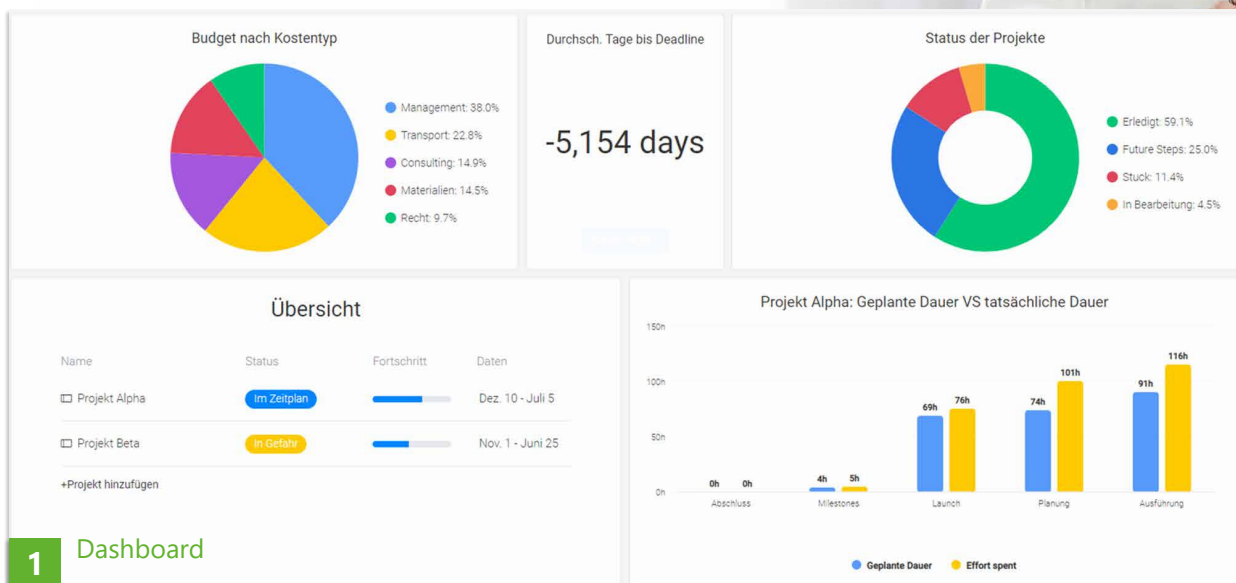

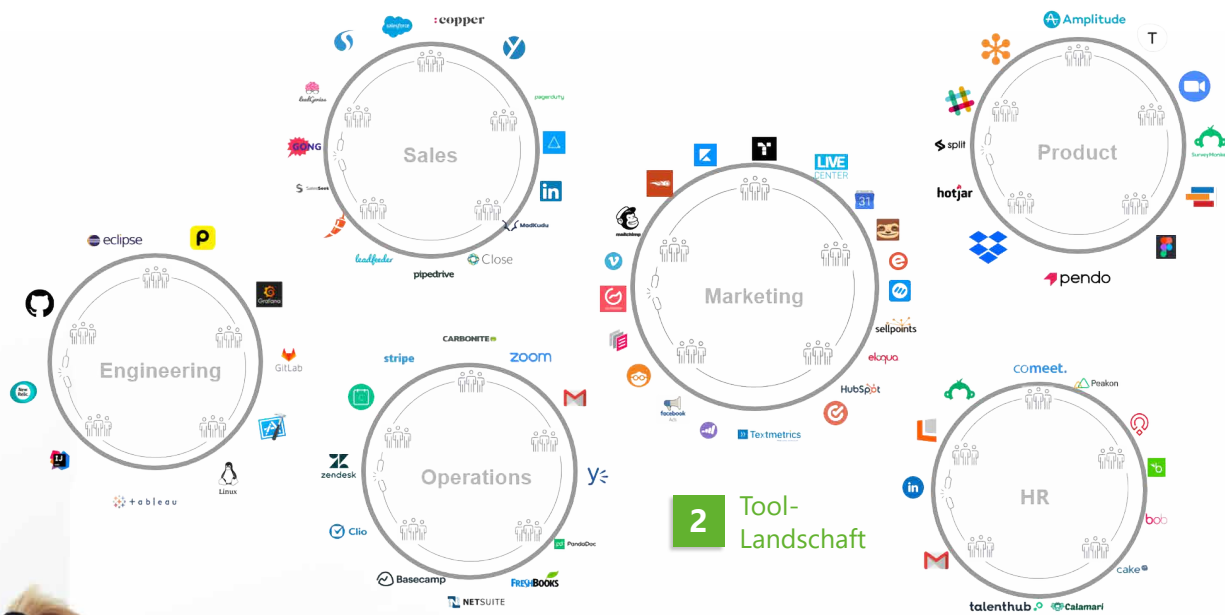

project progress, manage budgets, check team capacities, and monitor sales targets. Charts, timelines, or a master Gantt chart: With just a few clicks, users can create visually appealing dashboards to present the latest status report in the next meeting, directly from the tool. Hours of creating slides are replaced by an illustrative, automatically created visualization that can also be easily shared with team members and superiors.

**Scenario 2: Bringing order to the tool landscape**

Every project manager knows the problem: Their teams use different software solutions, especially when cooperation is between departments. Team A handles the project via Jira, team B via an Excel list, and the smaller sub-project is handled via OneNote and emails. Any connection is almost impossible. Ultimately what is required is ONE central place where all information is collected.

**The goal:** Efficient ways of working and a good overview across multiple teams even with different tools.

**The solution:** A cloud-based platform in particular, with integration options and room for “more” can help with this challenge. Again, monday.com offers numerous options for centrally pooling information from different tools: With 40 existing integrations, it is possible to connect Outlook, MS Teams, Dropbox, Jira, GitHub, GitLab, and many other tools to monday.com. Project managers can even automate the sending of emails from monday.com or synchronize information from Dropbox or Jira – all without having to create any program code themselves!

As for the “more”, monday.com offers an open interface based on the GraphQL structure. Using this API, project managers can import external data into their monday.com account or trigger actions directly in the tool in response to a change in external software or services.

 Outlook

Every time period, if status is something, send an email to someone

[Zum Board hinzufügen](#)

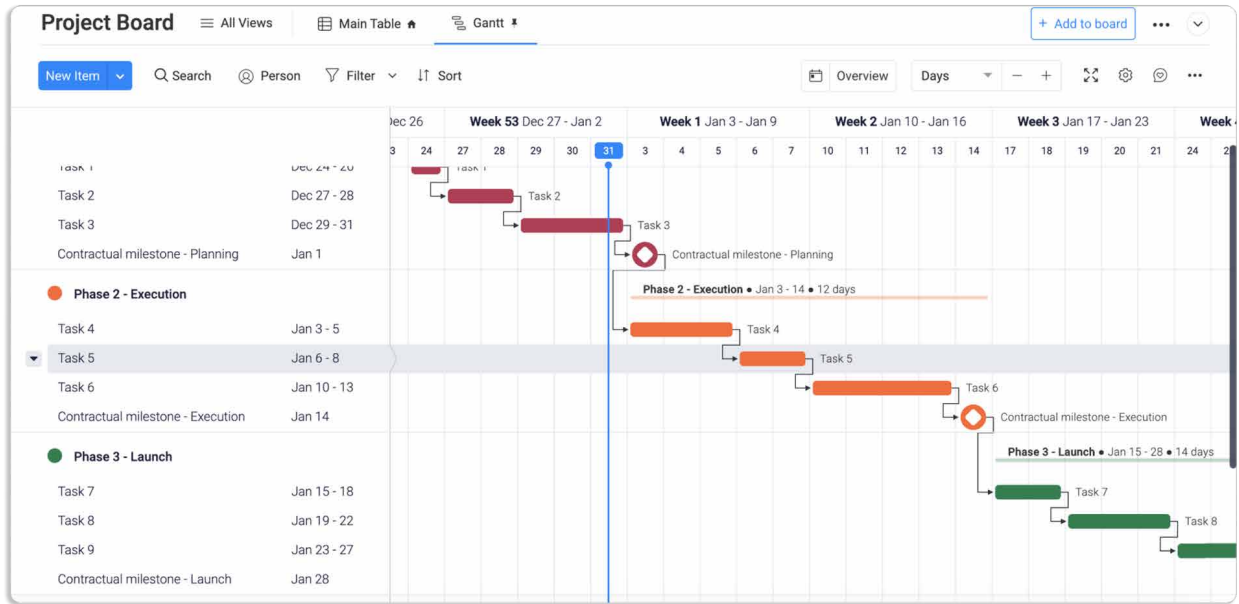

### 3 GANTT-Diagramm

#### Scenario 3: Increasing effectiveness and efficiency

Effectiveness focuses on the desired result or goal. Efficiency, on the other hand, means keeping the effort as low as possible in order to achieve the desired goal cost-effectively. The two ideals are not automatically compat-

ible – all the more reason to increase both.

**Goal:** To harmonize effectiveness and efficiency through professional project management – and to increase productivity, motivate employees, and facilitate good time management as a result.

**Solution:** The right tools can quantifiably increase both effectiveness and efficiency. The key element is optimized workflows. Professional project management via a cloud-based platform such as monday.com offers one transparent option in this regard, through which companies can illustrate work processes or projects indi-

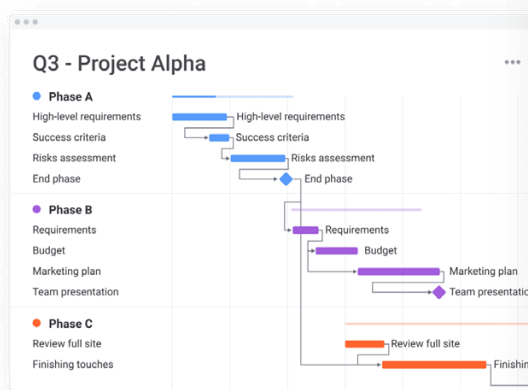

### 4 Different view options allow a quick project overview

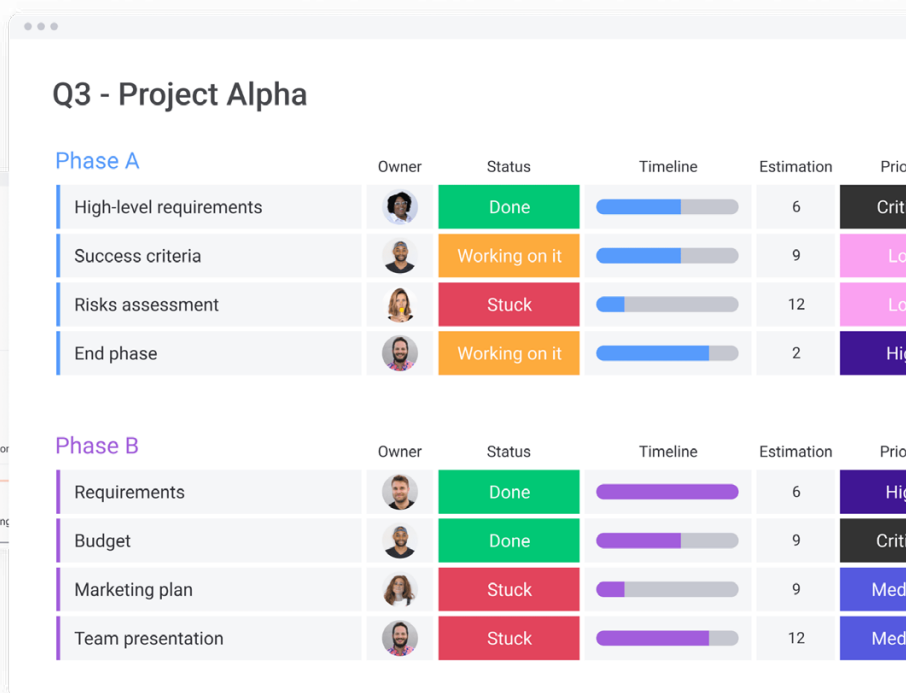

vidually and intuitively in order to maintain an overview at all times. Software automation reduces to a minimum the effort needed to maintain work processes and data.

Examples: Project managers can include dependencies in project steps so that deadlines are automatically shifted whenever any changes are made. Information on the project status or the achievement of a milestone can also be updated automatically and at regular intervals. Important: A solution should support the import and automated use of external data, including real-time synchronization.

If manual effort is reduced in this way and no time is wasted on unnecessary data searches, time management is improved considerably. This relieves project managers' workload, who can then use this breathing space for communication with their staff – which is key to satisfied team members, especially in the current era of working from home.

### Project management with monday.com

With monday.com, teams can improve internal workflows, maintain the focus on time management, and work more efficiently as a result. All information relevant to the respective project is displayed in a way that is easy to find. The cloud-based project and time management tool is extremely versatile – it can even be used to track time worked and for Customer Relationship Management (CRM). For further information please see: <https://tinyurl.com/MicroNova-WorkOS>.

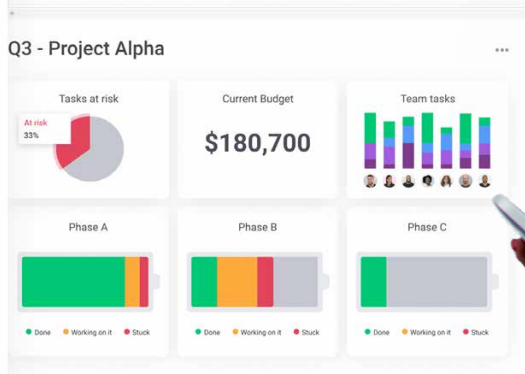
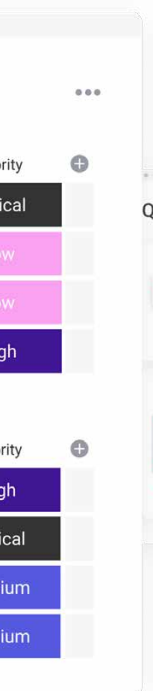

# TISAX Certification

MicroNova in Vierkirchen is already certified in accordance with the IT security standard of the automotive industry – further locations are set to follow in 2021.

**TEXT: Editorial staff**

Information security is a very important aspect in the customer relationship between automotive manufacturers and their vendors. For this reason, companies like MicroNova intending to work with OEMs and their vendors, both currently and in the future, must now be able to demonstrate a valid TISAX certification.

TISAX (Trusted Information Security Assessment Exchange) is an information security system defined by the automotive industry in 2017. A catalog covering industry-relevant IT security requirements was created in collaboration with a working group of the German Association of the Automotive Industry (VDA). It includes topics such as prototype protection, order processing, and relationships to external companies. It is called the "VDA Information Security Assessment" (VDA ISA) and forms the basis for preparing for TISAX certification. Although still relatively new, the standard is already an integral part of the purchasing conditions at many automotive companies.

## Extending MicroNova's certification

Following successful TISAX certification for the corporate headquarters in Vierkirchen in 2020, further sites are set to follow in the coming months.

"Based on a high level of transparency, a further optimization of our project structure, and an intensive risk management, we expect to be able to implement the certification of the sites just as smoothly and successfully as we have already succeeded in doing with our headquarters in Vierkirchen," explains Patrick Gerard, Head of IT at MicroNova. "Security awareness and handling data correctly form the basis for our long-term successful cooperation with companies in the automotive sector. TISAX certification confirms this way of working and makes compliance with all required IT security specifications verifiable to our partners."

TISAX certification means that MicroNova meets the security requirements for working with all major automotive manufacturers.



# Innovation as a Constant

Dear Reader,

It is not possible for me to mention here all the good innovative things that the MicroNova team has achieved despite coronavirus-related adversities. Allow me to give you a brief – albeit incomplete – summary of some of the topics covered in this issue of our InNOVation.

## Excellent cloud solution: Testing Solutions

One highlight is MicroNova's involvement in the development of a virtual integration platform for our customer CARIAD, the software company in the Volkswagen Group; one of the projects being undertaken there is the development of a uniform software platform for all of the Group's passenger car brands.

NovaCarts Virtual is the central building block of this testing and integration process, which verifies and optimizes technologies for intelligent and connected vehicles by combining cloud-based virtual and/or real environments. Our customer CARIAD has been nominated for the Red Hat Innovation Award 2021 for its virtual integration platform and its architecture – a great honor for CARIAD and an accolade for our team, which has achieved technical market leadership here. We are grateful that we were able to participate in such a successful project.

## 5G – SDN – IoT: Telco Solutions

5G is not an evolution, 5G is a revolution – and it is set to transform a lot of things. Innovative approaches are needed to meet the requirements for services, applications, and business models. Software-defined networking (SDN) constitutes an important technology for this purpose, and COM5.SDN is a fitting solution from MicroNova. And there are other areas where MicroNova is involved and which are reported on in detail in this InNOVation:

- » Grey spot sharing – allowing Telekom, Vodafone and Telefónica to use each other's infrastructure to work together to close gaps in the network.
- » Network slicing – enabling companies to operate their own independent virtual networks.
- » Internet-of-Things (IoT) – connecting devices, sharing sensor-based data and turning them into valuable information, for example, for predictive maintenance, new services to name but a few.
- » Artificial intelligence (AI) – for example, for analyzing network data managed via COM5.Mobile for use in the new COM5.SDN product generation. AI can also build a bridge from Telco Solutions to the automotive sector, e.g. for future services relating to autonomous driving.

I find our dedicated students and their innovative contributions particularly remarkable. The article "With AI into the Net", for example, comes from our intern Ella Schmidtobreick, who graduated from Gymnasium Indersdorf, a high school that MicroNova supports in a number of ways, including the robotics competition. It is precisely this mix, or rather the collaboration between young and experienced people from near and (very) far in our teams, that keeps us fresh and at the leading edge of technology.

## IT Management

The example of the IoT shows that it may be externally driven innovation as well if it is compelling. Our IT Management division proves how successful this can be with the distribution of solutions for IT management, IT security and project management.

## Our Corporate IT

Our successes underscore the great importance of smoothly operating corporate IT. This is also true for MicroNova, of course: our support team has done an excellent job of enabling 90% of our colleagues to work so well from home for almost a year now. So a big thank you for that, dear IT – on behalf of all of us.

With warm regards,  
Josef W. Karl



Josef W. Karl

**Publisher:**

MicroNova AG  
Unterfeldring 6  
D-85256 Vierkirchen  
Phone: +49 8139 9300-0  
Fax: +49 8139 9300-80  
Email: info@micronova.de

**Editors:**

Katharina Hampe  
Regina Schwarzenböck  
Stefan Karl (GP)  
Martina Heinze

**Design:**

Christoph Buchner

**Printed by:**

Offsetdruckerei Gebr. Betz GmbH,  
Weichs

**Circulation:** 1,500 copies

**Frequency of publication:**

MicroNova's InNOVation is published two times a year. Additional special editions might be published.

**Copyright:**

Page 001/048:

© Blue Planet Studio / Shutterstock.com; weitere siehe jeweilige Artikel

Page 003:

© see respective articles

Page 046/047:

© shumo4ka / Fotolia.com

**If you would like to place an order, change or cancel your subscription, please contact:**

Phone: +49 8139 9300-0  
Email: info@micronova.de

All product names, trademarks or trade names are property of their respective owners. All articles and illustrations are protected by copyright. Copying or reprinting is only permitted with the express permission of the publisher. The information contained in this customer magazine regarding products and services does not represent a warranty of properties.

Printed on paper treated with chlorine-free bleach.

© MicroNova, 2021